

Quick Installation Guide

300Mbps Wireless N Router

Please select your preferred configuration method:

Method 1 >> Configuration via CD Setup Wizard

For Windows users only

Method 2 >> Configuration via Web-based Quick Setup Wizard

For Mac OS/Linux users or Windows users who cannot run mini CD

MODEL NO. TL-WR841N/TL-WR841ND

Package Contents

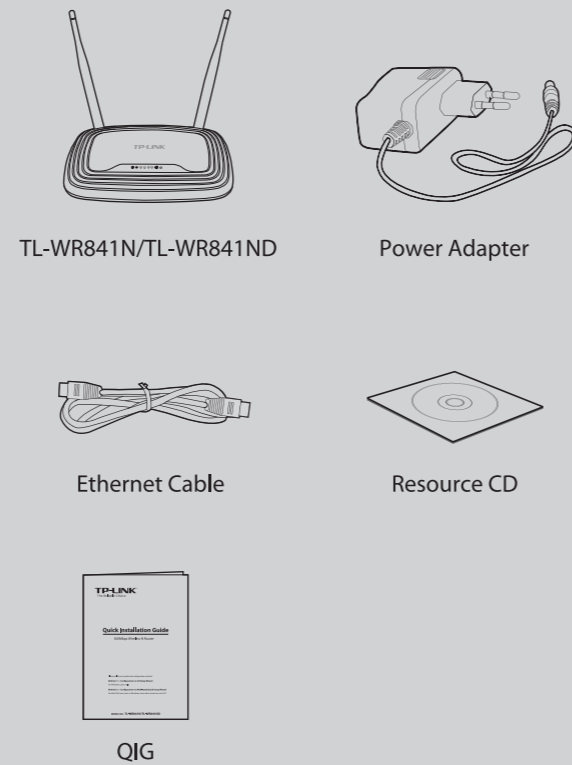

1 Hardware Connection

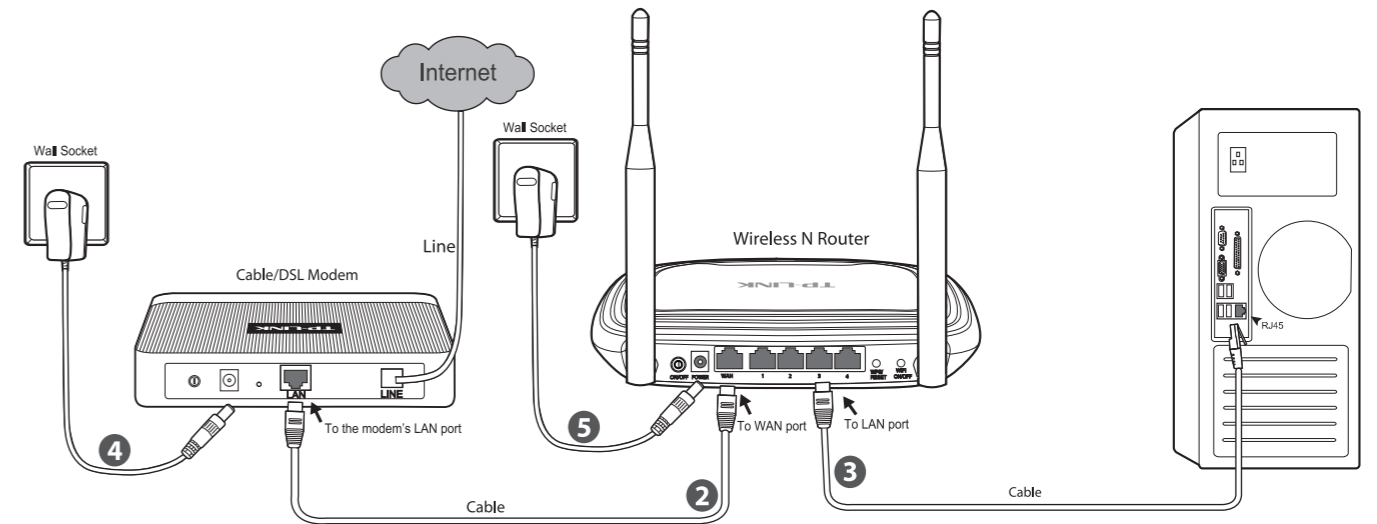

- ❶ Power off your modem.
- ❷ Connect the **WAN** port on your Router to the modem's **LAN** port with an Ethernet cable.
- ❸ Connect your computer to one of the LAN ports labeled **1~4** on the Router with an Ethernet cable.
- ❹ Power on the modem and wait for one minute.
- ❺ Plug the provided Power Adapter into the **POWER** jack on the back of the Router and the other end to a standard electrical wall socket. Press the **ON/OFF** button to power on the Router.

Note Please confirm that the **WLAN** light is **ON** so that client devices can connect to the router wirelessly. Press the **WIFI** button for more than 2 seconds to turn on or turn off the wireless function.

Method 1 >> Configuration via CD Setup Wizard

Note This method is only for Windows users who can run the mini CD.

- ❶ Insert the TP-LINK Resource CD into the CD-ROM drive.

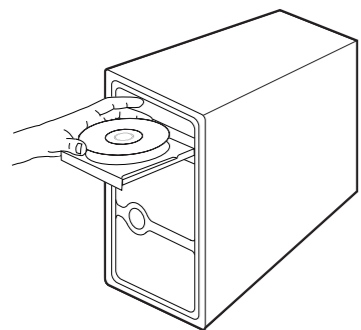

- ❷ Select **TL-WR841ND** and click **Easy Setup Assistant**.



- ❸ Select your language from the drop-down menu. Click **START** and the **Easy Setup Assistant** will guide you step by step to set up the Router.



- ❹ Follow the instructions until you see the screen below. Click **FINISH** to complete the setup.

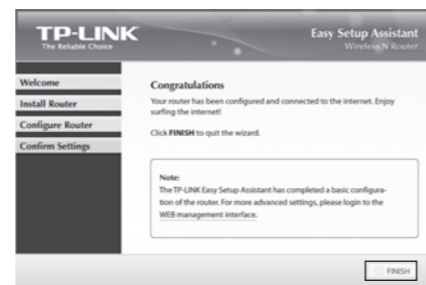

Note You can click **WEB management interface** for more advanced settings.

Method 2 >> Configuration via Web-based Quick Setup Wizard

Note This method is for Mac OS/Linux users or Windows users who cannot run the mini CD.

- ❶ Open your browser and type **http://tplinklogin.net** in the address field, then use the user name **admin** and password **admin** to log in.

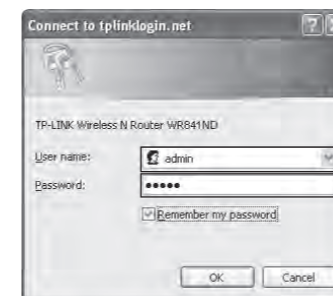

Note If the login window fails to pop up or you cannot access the management page after the login window, please refer to **Troubleshooting-2**.

- ❷ Click **Quick Setup** in the main menu and click **Next**.

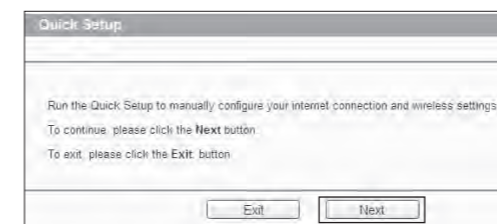

Note The Router will automatically detect the Internet connection. If the Internet is available, the Router will direct you to **Step 5**; otherwise, you need to continue with **Step 3**.

- ❸ Select **Auto-Detect** to detect the Internet connection type and click **Next**. (The Dynamic IP is the suitable connection type for most cases, so we take it as an example in the following.)

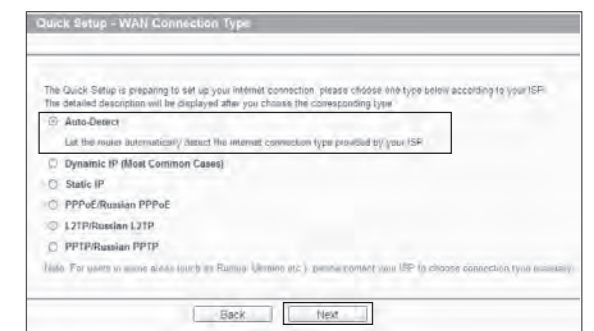

(To be continued...)

Method 2 >> Configuration via Web-based Quick Setup Wizard (Continued)

- 4** If **Dynamic IP** is detected, there will appear the MAC Clone page. In most cases, there is no need to clone the MAC address. You can select **"No, I do NOT need to clone MAC address"** and then click **Next** to continue.

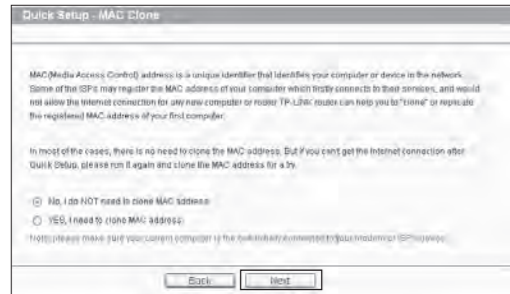

- 5** You can rename your wireless network and create your own password on this page. The default wireless network name is TP-LINK_XXXXXX; and the default wireless password, the same as the PIN code, is printed on the bottom label. Click **Next** to continue.

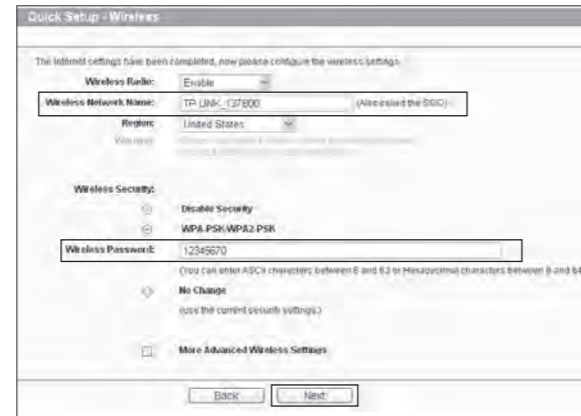

- 6** Click **Finish** to make your settings take effect.

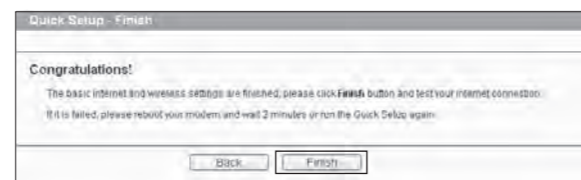

Appendix: Additional Features

You can set up additional features by referring to the Technical Support page on the TP-LINK website or the User Guide on the resource CD.



Scan the QR code to access the Technical Support page.

Or access the website: <http://www.tp-link.com/en/support/faq>



- Open ports for Game Console FAQ ID: 72
- Set up Bandwidth Control FAQ ID: 194
- Set up Parental Control FAQ ID: 350
- Set up Access Control FAQ ID: 359
- Set up WDS Bridging FAQ ID: 440
- Set up/Change the wireless security settings FAQ ID: 256
- Upgrade the firmware FAQ ID: 296
- Restore the factory default settings FAQ ID: 426

Troubleshooting

1. What can I do if I cannot access the Internet?

- 1) Make sure that computer can access the Internet when connected directly to the modem using an Ethernet cable.
- 2) Check that if all cables are connected correctly. Try different Ethernet cables to ensure they are working properly.
- 3) Check that if you are able to access the Router's web management page. If not, please refer to **"What can I do if I cannot open the web-based management page?"**.
- 4) Please log in the web management page (<http://tplinklogin.net>), click the menu **"Network > WAN"**, and ensure that the WAN Connection Type is Dynamic IP; this is the suitable connection type for most DSL/Cable modem and other network.
- 5) For cable modem users, please try rebooting the modem first. If the problem persists, please go to **"Network > MAC Clone"**, and click **Clone MAC Address** and then **Save**. After the above two steps, if you are still unable to access the Internet, please contact our technical support for further assistance.

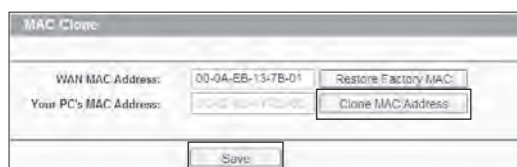

2. What can I do if I cannot open the web-based management page?

- 1) Verify all the hardware connections. The computer should be connected to the Ethernet port (yellow).
- 2) Turn off the router and turn it back on.
- 3) Change another cable/web browser/computer.
- 4) Check the IP settings of your computer, and ensure that it is set to "Obtain an IP address automatically".

3. How do I restore my Router's configuration to its factory default settings?

If your router does not work properly, you can reset it and then configure it again. With the Router powered on, press and hold the **WPS/RESET** button on the rear panel for approximately 8 seconds before releasing it.

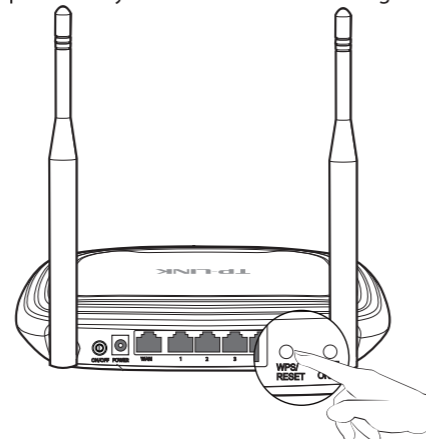

4. What can I do if I forget my password?

- 1) For default wireless password:
Please refer to the **"Wireless Password/PIN"** labeled on the bottom of the Router.
- 2) For the web management page password:
Reset the router first and then use the default user name and password: admin, admin.

Technical Support

- For more troubleshooting help, go to www.tp-link.com/en/support/faq
 - To download the latest Firmware, Driver, Utility and User Guide, go to <http://www.tp-link.com/en/support/download/>
 - For all other technical support, please contact us by using the following details:
- | | |
|---|---|
| <p>Global
Tel: +86 755 2650 4400
Fee: Depending on rate of different carriers, IDD.
E-mail: support@tp-link.com
Service time: 24hrs, 7 days a week</p> <p>Singapore
Tel: +65 6284 0493
Fee: Depending on rate of different carriers.
E-mail: support.sg@tp-link.com
Service time: 24hrs, 7 days a week</p> <p>UK
Tel: +44 (0) 845 147 0017
Fee: Landline: 1p-10.5p/min, depending on the time of day. Mobile: 15p-40p/min, depending on your mobile network.
E-mail: support.uk@tp-link.com
Service time: 24hrs, 7days a week</p> <p>USA / Canada
Toll Free: +1 866 225 8139
E-mail: support.usa@tp-link.com(USA)
support.usa@tp-link.com(Canada)
Service time: 24hrs, 7days a week</p> <p>Malaysia
Toll Free: 1300 88 875 465
E-mail: support.my@tp-link.com
Service time: 24hrs, 7days a week</p> <p>Ukraine
Tel: 0 800 505 508
Fee: Free for Landline; Mobile: Depending on rate of different carriers
E-mail: support.ua@tp-link.com
Service time: Monday to Friday 10:00 to 22:00</p> <p>Italy
Tel: +39 023 051 9020
Fee: Depending on rate of different carriers.
E-mail: support.it@tp-link.com
Service time: Monday to Friday, 09:00 to 13:00; 14:00 to 18:00</p> <p>Germany / Austria
Tel: +49 1805 875 465 (German Service)
+49 1805 TPLINK
+43 820 820 360
Fee: Landline from Germany: 0.14EUR/min. Landline from Austria: 0.20EUR/min.
E-mail: support.de@tp-link.com
Service Time: Monday to Friday, 09:00 to 12:30 and 13:30 to 18:00. GMT+1 or GMT+2 (DST in Germany)
* Except bank holidays in Hesse</p> | <p>Australia / New Zealand
Tel: AU 1300 87 5465 (Depending on 1300 policy). NZ 0800 87 5465 (Toll Free)
E-mail: support.au@tp-link.com (Australia)
support.nz@tp-link.com (New Zealand)
Service time: 24hrs, 7 days a week</p> <p>Turkey
Tel: 0850 72 444 88 (Turkish Service)
Fee: Depending on rate of different carriers.
E-mail: support.tr@tp-link.com
Service time: 9:00 to 21:00, 7days a week</p> <p>Switzerland
Tel: +41 (0) 848 800 998 (German Service)
E-mail: support.ch@tp-link.com
Fee: 4-8 Rp/min, depending on rate of different time
Service time: Monday to Friday, 09:00 to 12:30 and 13:30 to 18:00. GMT+ 1 or GMT+ 2 (DST)</p> <p>Brazil
Toll Free: 0800 608 9799 (Portuguese Service)
E-mail: support.br@tp-link.com
Service time: Monday to Friday, 9:00 to 20:00; Saturday, 9:00 to 15:00</p> <p>Poland
Tel: +48 (0) 801 080 618
+48 223 606 363 (if calls from mobile phone)
Fee: Depending on rate of different carriers.
E-mail: support.pl@tp-link.com
Service time: Monday to Friday 9:00 to 17:00 GMT+1 or GMT+2 (DST)</p> <p>France
Tel: 0820 800 860 (French service)
Email: support.fr@tp-link.com
Fee: 0.118 EUR/min from France
Service time: Monday to Friday, 9:00 to 18:00 *Except French Bank holidays</p> <p>Indonesia
Tel: (+62) 021 6386 1936
Fee: Depending on rate of different carriers.
E-mail: support.id@tp-link.com
Service time: Sunday to Friday, 09:00 to 12:00, 13:00 to 18:00 *Except public holidays</p> <p>Russian Federation
Tel: 8 (499) 754 5560 (Moscow NO.)
8 (800) 250 5560 (Toll-free within RF)
E-mail: support.ru@tp-link.com
Service times: From 9:00 to 21:00 (Moscow time)
*Except weekends and holidays in RF</p> |
|---|---|