

### SIPMOS<sup>®</sup> Power Transistor

- N channel
- Enhancement mode
- Avalanche-rated
- $dv/dt$  rated
- Ultra low on-resistance
- 175°C operating temperature
- also in TO-220 SMD available

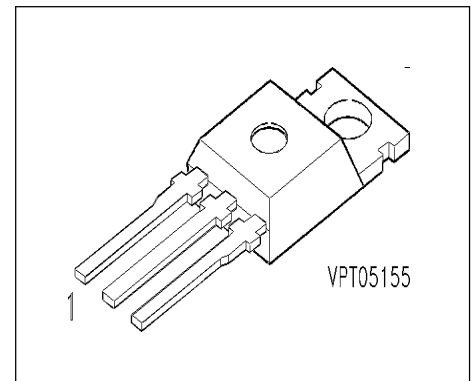

| Pin 1 | Pin 2 | Pin 3 |
|-------|-------|-------|
| G     | D     | S     |

| Type    | $V_{DS}$ | $I_D$ | $R_{DS(on)}$   | Package   | Ordering Code   |
|---------|----------|-------|----------------|-----------|-----------------|
| BUZ 100 | 50 V     | 60 A  | 0.018 $\Omega$ | TO-220 AB | C67078-S1348-A2 |

### Maximum Ratings

| Parameter  | Symbol      | Values        | Unit              |
|--|-------------|---------------|-------------------|
| Continuous drain current<br>$T_C = 101\text{ }^\circ\text{C}$  | $I_D$       | 60            | A                 |
| Pulsed drain current<br>$T_C = 25\text{ }^\circ\text{C}$   | $I_{Dpuls}$ | 240           | A                 |
| Avalanche energy, single pulse<br>$I_D = 60\text{ A}$ , $V_{DD} = 25\text{ V}$ , $R_{GS} = 25\text{ }\Omega$<br>$L = 70\text{ }\mu\text{H}$ , $T_j = 25\text{ }^\circ\text{C}$ | $E_{AS}$    | 250           | mJ                |
| Reverse diode $dv/dt$<br>$I_S = 60\text{ A}$ , $V_{DS} = 40\text{ V}$ , $di_F/dt = 200\text{ A}/\mu\text{s}$<br>$T_{jmax} = 175\text{ }^\circ\text{C}$                         | $dv/dt$     | 6             | kV/ $\mu\text{s}$ |
| Gate source voltage  | $V_{GS}$    | $\pm 20$      | V                 |
| Power dissipation<br>$T_C = 25\text{ }^\circ\text{C}$  | $P_{tot}$   | 250           | W                 |
| Operating temperature  | $T_j$       | -55 ... + 175 | $^\circ\text{C}$  |
| Storage temperature  | $T_{stg}$   | -55 ... + 175 | $^\circ\text{C}$  |
| Thermal resistance, chip case  | $R_{thJC}$  | $\leq 0.6$    | K/W               |
| Thermal resistance, chip to ambient  | $R_{thJA}$  | $\leq 75$     | K/W               |
| DIN humidity category, DIN 40 040  |             | E             |                   |
| IEC climatic category, DIN IEC 68-1  |             | 55 / 175 / 56 |                   |

**Electrical Characteristics, at  $T_j = 25^\circ\text{C}$ , unless otherwise specified**

| Parameter   | Symbol        | Values |       |       | Unit          |
|---|---------------|--------|-------|-------|---------------|
|   |               | min.   | typ.  | max.  |               |
| <b>Static Characteristics</b>   |               |        |       |       |               |
| Drain- source breakdown voltage<br>$V_{GS} = 0\text{ V}$ , $I_D = 0.25\text{ mA}$ , $T_j = -40\text{ }^\circ\text{C}$ | $V_{(BR)DSS}$ | 50     | -     | -     | V             |
| Gate threshold voltage<br>$V_{GS} = V_{DS}$ , $I_D = 1\text{ mA}$   | $V_{GS(th)}$  | 2.1    | 3     | 4     |               |
| Zero gate voltage drain current<br>$V_{DS} = 50\text{ V}$ , $V_{GS} = 0\text{ V}$ , $T_j = 25\text{ }^\circ\text{C}$  | $I_{DSS}$     | -      | 0.1   | 1     | $\mu\text{A}$ |
| $V_{DS} = 50\text{ V}$ , $V_{GS} = 0\text{ V}$ , $T_j = -40\text{ }^\circ\text{C}$                                    |               | -      | 1     | 100   | nA            |
| $V_{DS} = 50\text{ V}$ , $V_{GS} = 0\text{ V}$ , $T_j = 150\text{ }^\circ\text{C}$                                    |               | -      | 10    | 100   | $\mu\text{A}$ |
| Gate-source leakage current<br>$V_{GS} = 20\text{ V}$ , $V_{DS} = 0\text{ V}$   | $I_{GSS}$     | -      | 10    | 100   | nA            |
| Drain-Source on-resistance<br>$V_{GS} = 10\text{ V}$ , $I_D = 60\text{ A}$  | $R_{DS(on)}$  | -      | 0.013 | 0.018 | $\Omega$      |

**Electrical Characteristics, at  $T_j = 25^\circ\text{C}$ , unless otherwise specified**

| Parameter  | Symbol       | Values |      |      | Unit |
|--|--------------|--------|------|------|------|
|  |              | min.   | typ. | max. |      |
| <b>Dynamic Characteristics</b>   |              |        |      |      |      |
| Transconductance<br>$V_{DS} \geq 2 \cdot I_D \cdot R_{DS(on)max}$ , $I_D = 60 \text{ A}$                               | $g_{fs}$     | 25     | 39   | -    | S    |
| Input capacitance<br>$V_{GS} = 0 \text{ V}$ , $V_{DS} = 25 \text{ V}$ , $f = 1 \text{ MHz}$                            | $C_{iss}$    | -      | 2400 | 3200 | pF   |
| Output capacitance<br>$V_{GS} = 0 \text{ V}$ , $V_{DS} = 25 \text{ V}$ , $f = 1 \text{ MHz}$                           | $C_{oss}$    | -      | 800  | 1200 |      |
| Reverse transfer capacitance<br>$V_{GS} = 0 \text{ V}$ , $V_{DS} = 25 \text{ V}$ , $f = 1 \text{ MHz}$                 | $C_{rss}$    | -      | 300  | 450  |      |
| Turn-on delay time<br>$V_{DD} = 30 \text{ V}$ , $V_{GS} = 10 \text{ V}$ , $I_D = 3 \text{ A}$<br>$R_{GS} = 50 \Omega$  | $t_{d(on)}$  | -      | 40   | 60   | ns   |
| Rise time<br>$V_{DD} = 30 \text{ V}$ , $V_{GS} = 10 \text{ V}$ , $I_D = 3 \text{ A}$<br>$R_{GS} = 50 \Omega$           | $t_r$        | -      | 100  | 150  |      |
| Turn-off delay time<br>$V_{DD} = 30 \text{ V}$ , $V_{GS} = 10 \text{ V}$ , $I_D = 3 \text{ A}$<br>$R_{GS} = 50 \Omega$ | $t_{d(off)}$ | -      | 250  | 335  |      |
| Fall time<br>$V_{DD} = 30 \text{ V}$ , $V_{GS} = 10 \text{ V}$ , $I_D = 3 \text{ A}$<br>$R_{GS} = 50 \Omega$           | $t_f$        | -      | 140  | 190  |      |

**Electrical Characteristics, at  $T_j = 25^\circ\text{C}$ , unless otherwise specified**

| Parameter   | Symbol   | Values |      |      | Unit          |
|---|----------|--------|------|------|---------------|
|   |          | min.   | typ. | max. |               |
| <b>Reverse Diode</b>  |          |        |      |      |               |
| Inverse diode continuous forward current<br>$T_C = 25^\circ\text{C}$                          | $I_S$    | -      | -    | 60   | A             |
| Inverse diode direct current, pulsed<br>$T_C = 25^\circ\text{C}$                              | $I_{SM}$ | -      | -    | 240  |               |
| Inverse diode forward voltage<br>$V_{GS} = 0\text{ V}, I_F = 120\text{ A}$                    | $V_{SD}$ | -      | 1.4  | 1.8  | V             |
| Reverse recovery time<br>$V_R = 30\text{ V}, I_F = I_S, di_F/dt = 100\text{ A}/\mu\text{s}$   | $t_{rr}$ | -      | 70   | -    | ns            |
| Reverse recovery charge<br>$V_R = 30\text{ V}, I_F = I_S, di_F/dt = 100\text{ A}/\mu\text{s}$ | $Q_{rr}$ | -      | 0.16 | -    | $\mu\text{C}$ |

### Power dissipation

$$P_{\text{tot}} = f(T_C)$$

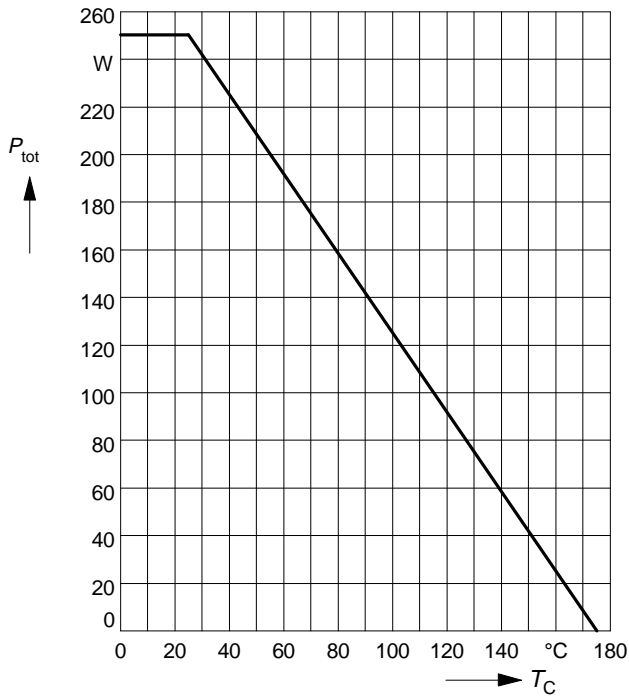

### Drain current

$$I_D = f(T_C)$$

parameter:  $V_{GS} \geq 10 \text{ V}$

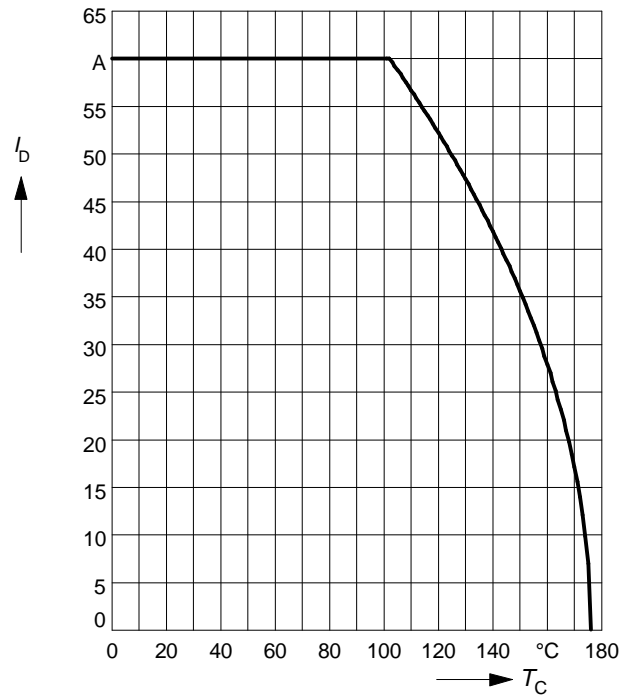

### Safe operating area

$$I_D = f(V_{DS})$$

parameter:  $D = 0.01$ ,  $T_C = 25^\circ\text{C}$

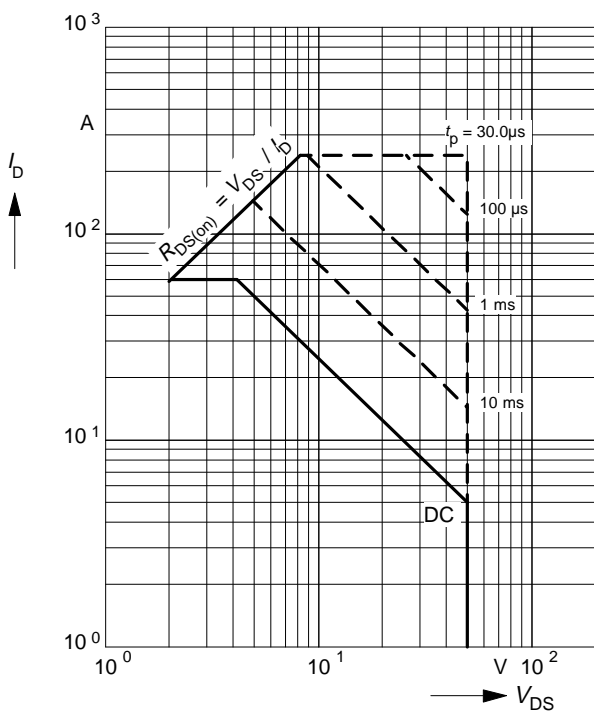

### Transient thermal impedance

$$Z_{\text{thJC}} = f(t_p)$$

parameter:  $D = t_p / T$

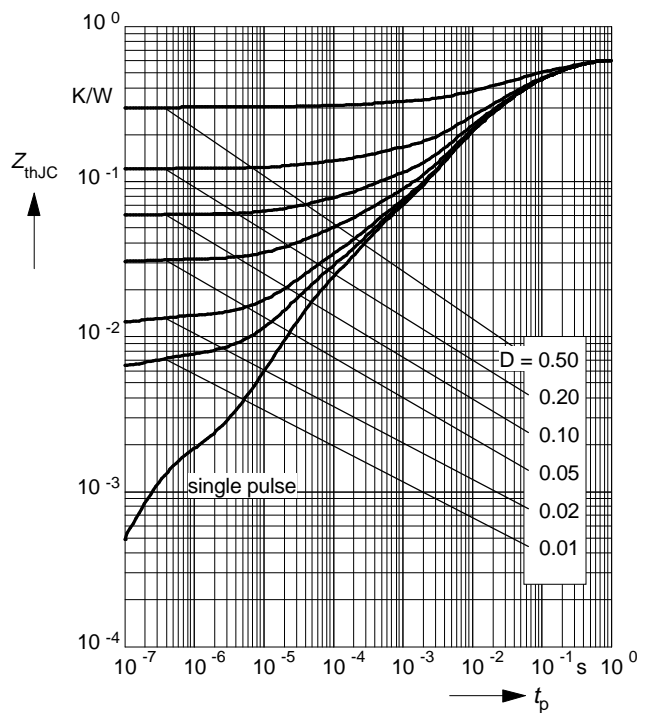

### Typ. output characteristics

$$I_D = f(V_{DS})$$

parameter:  $t_p = 80 \mu s$

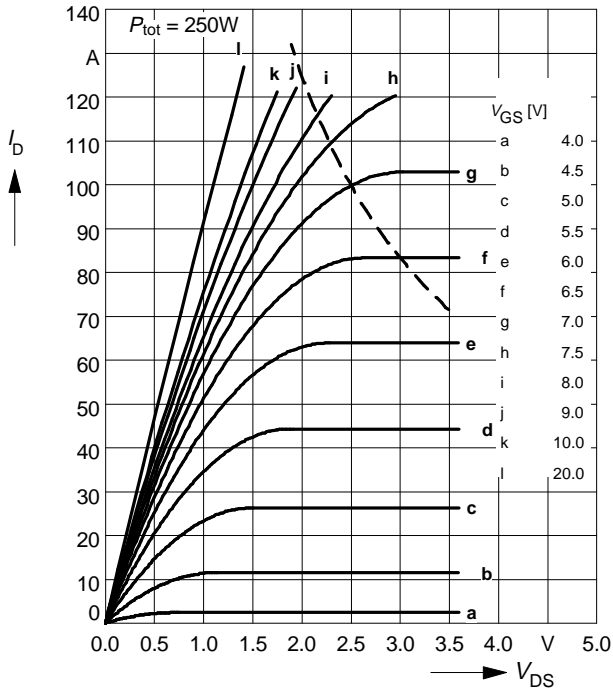

### Typ. drain-source on-resistance

$$R_{DS(on)} = f(I_D)$$

parameter:  $V_{GS}$

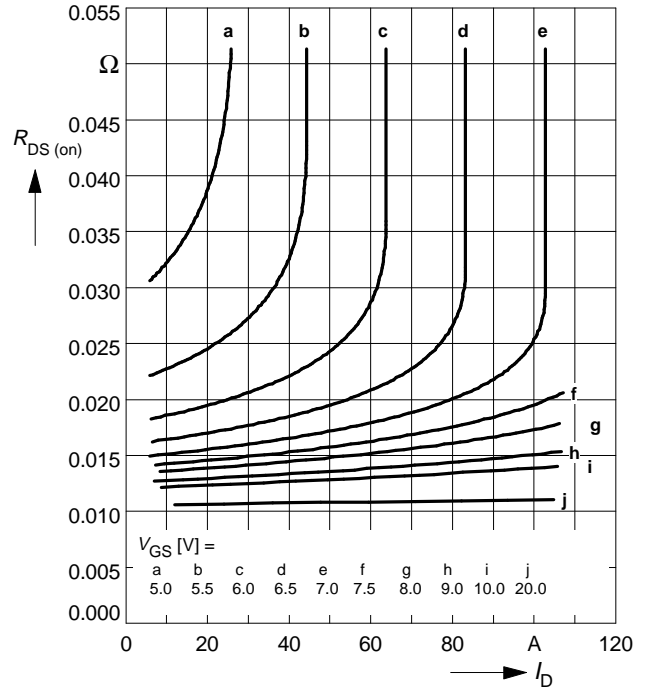

### Typ. transfer characteristics $I_D = f(V_{GS})$

parameter:  $t_p = 80 \mu s$

$$V_{DS} \geq 2 \times I_D \times R_{DS(on)max}$$

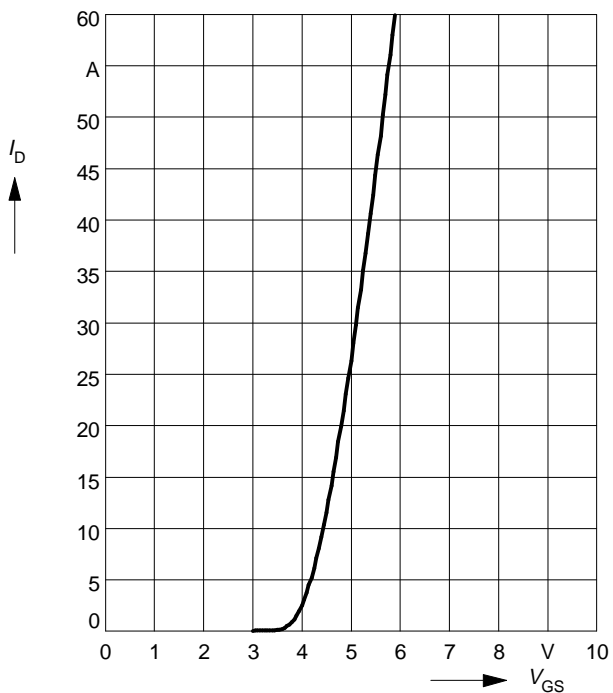

### Typ. forward transconductance $g_{fs} = f(I_D)$

parameter:  $t_p = 80 \mu s$ ,

$$V_{DS} \geq 2 \times I_D \times R_{DS(on)max}$$

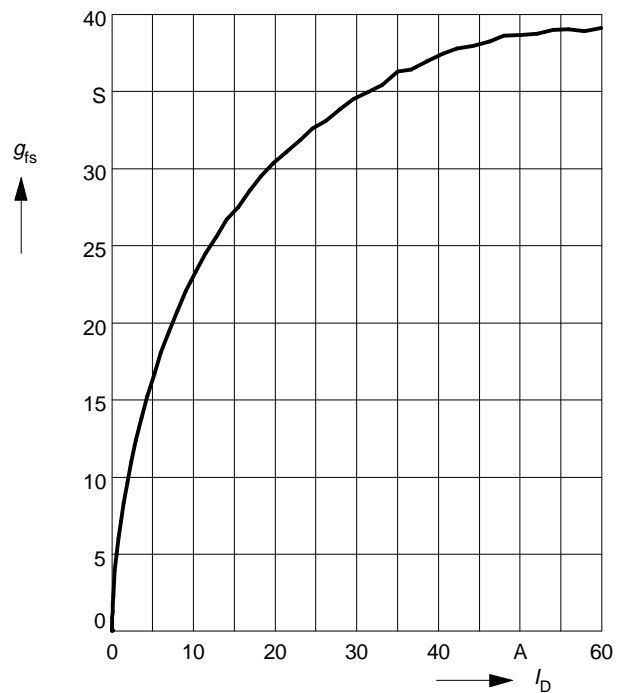

### Drain-source on-resistance

$$R_{DS(on)} = f(T_j)$$

parameter:  $I_D = 60\text{ A}$ ,  $V_{GS} = 10\text{ V}$

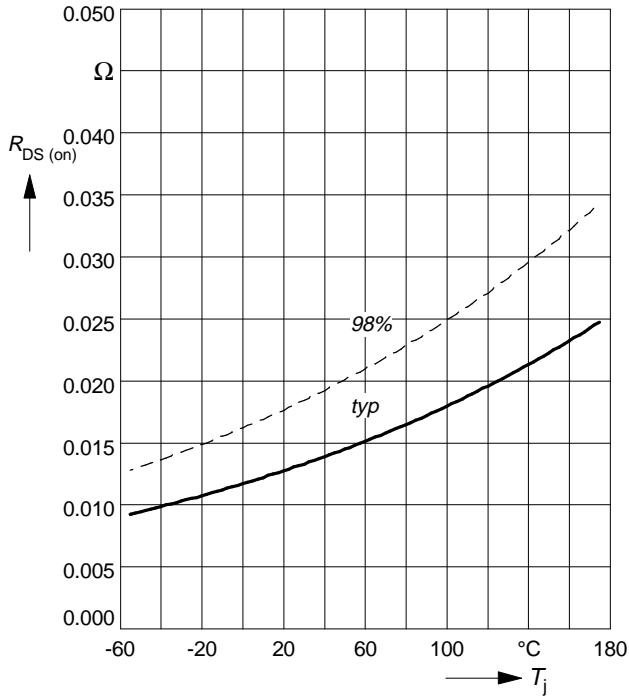

### Gate threshold voltage

$$V_{GS(th)} = f(T_j)$$

parameter:  $V_{GS} = V_{DS}$ ,  $I_D = 1\text{ mA}$

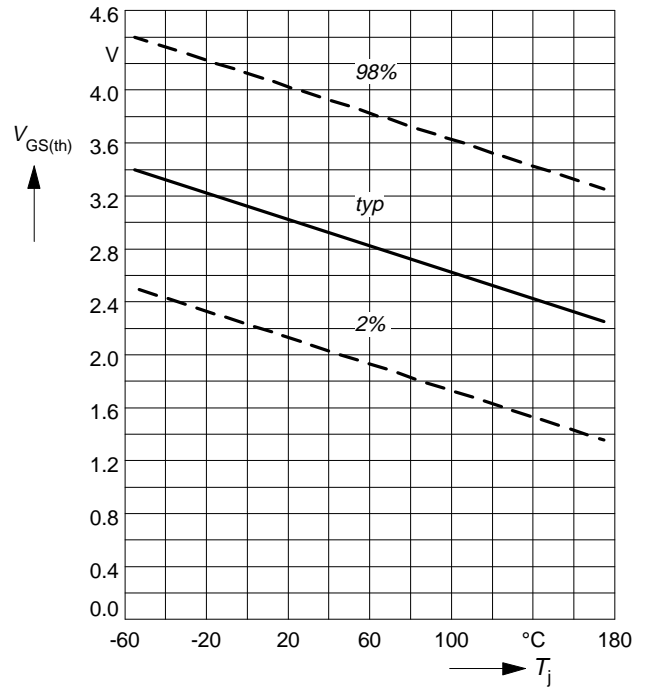

### Typ. capacitances

$$C = f(V_{DS})$$

parameter:  $V_{GS} = 0\text{ V}$ ,  $f = 1\text{ MHz}$

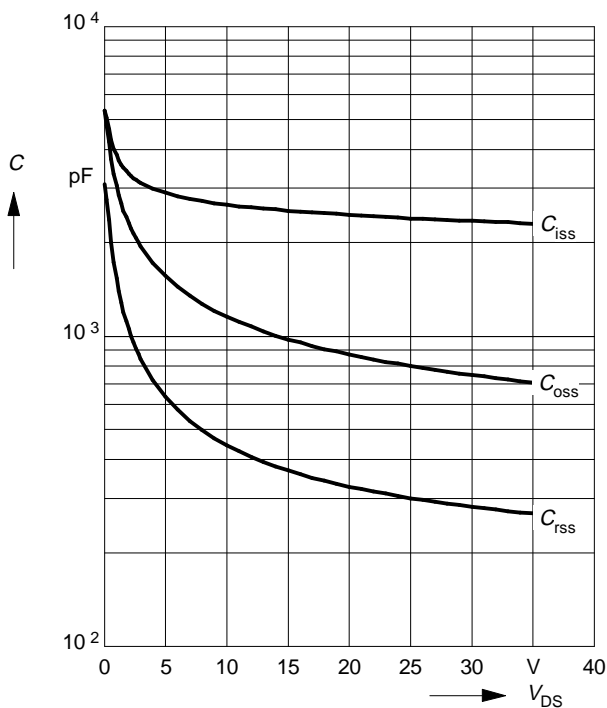

### Forward characteristics of reverse diode

$$I_F = f(V_{SD})$$

parameter:  $T_j$ ,  $t_p = 80\text{ }\mu\text{s}$

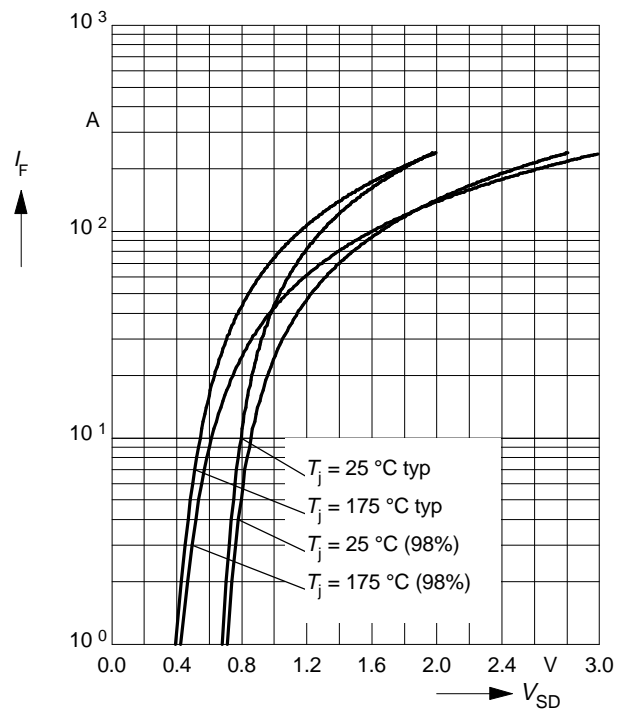

### Avalanche energy $E_{AS} = f(T_j)$

parameter:  $I_D = 60 \text{ A}$ ,  $V_{DD} = 25 \text{ V}$

$R_{GS} = 25 \Omega$ ,  $L = 70 \mu\text{H}$

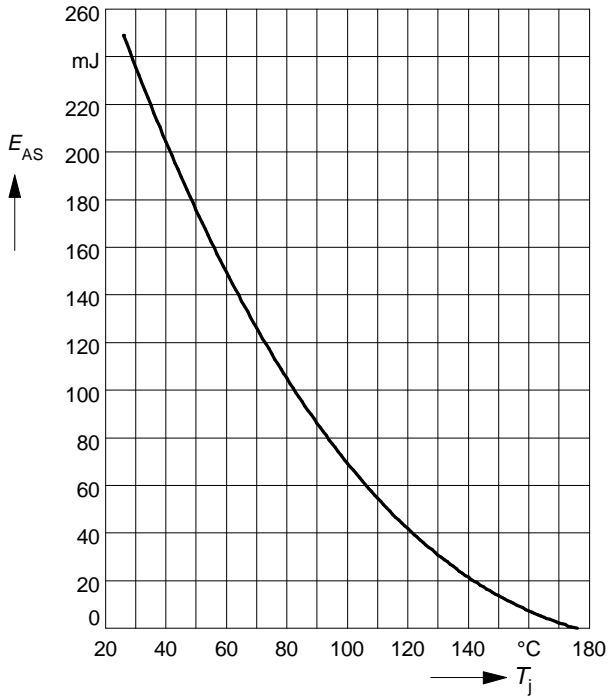

### Typ. gate charge $V_{GS} = f(Q_{Gate})$

parameter:  $I_{D \text{ puls}} = 90 \text{ A}$

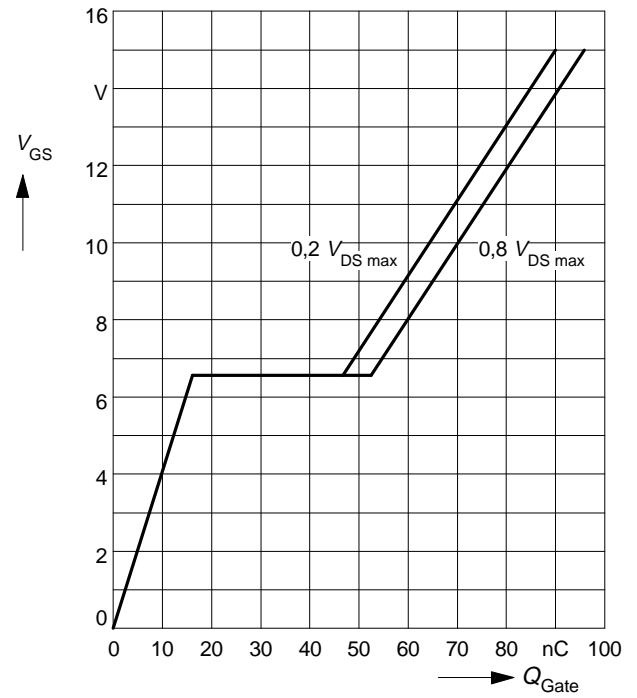

### Drain-source breakdown voltage $V_{(BR)DSS} = f(T_j)$

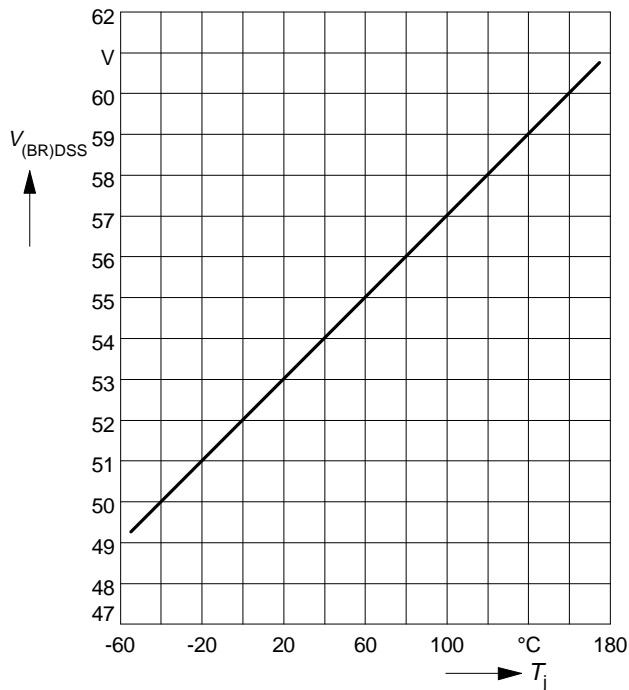

## Package Outlines

TO-220 AB

Dimension in mm

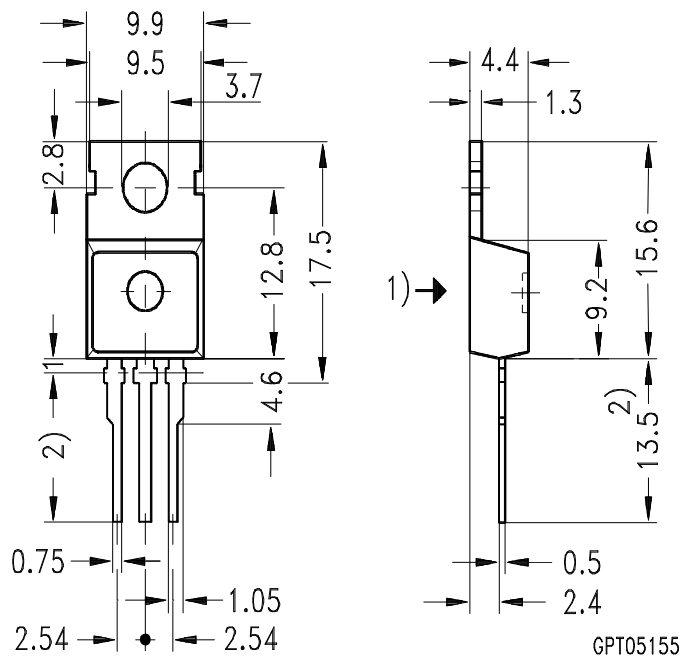

GPT05155

- 1) punch direction, burr max. 0.04
- 2) dip tinning
- 3) max. 14.5 by dip tinning press burr max. 0.05