

New



RoHS compliant

* Protective construction: Flux-resistant type

FEATURES

1. Miniature size and small: 10(W) · 20(L) · 16(H) mm .394(W) · .787(L) · .630(H) inch
2. Compact with high capacity: 1 Form A and 1 Form C, 10 A
3. Ambient temperature: -40°C to +85°C -40°F to 185°F
4. High surge voltage: 8,000 V between contacts and coil
5. High breakdown voltage: 4,000 V between contacts and coil

TYPICAL APPLICATIONS

1. Household appliances
Air conditioners, Refrigerators, Fan heaters, Microwave ovens, Inverter and Hot water units

ORDERING INFORMATION

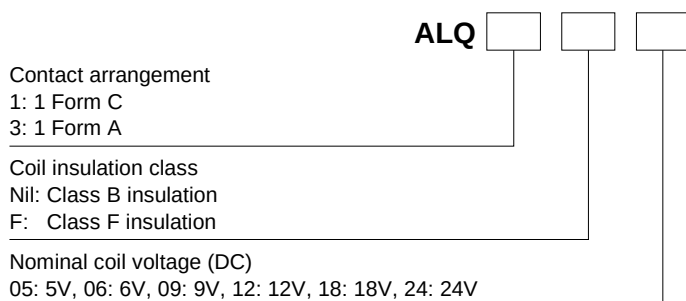

TYPES

Nominal coil voltage	1 Form A	1 Form C
	Part No.	Part No.
5V DC	ALQ305	ALQ105
6V DC	ALQ306	ALQ106
9V DC	ALQ309	ALQ109
12V DC	ALQ312	ALQ112
18V DC	ALQ318	ALQ118
24V DC	ALQ324	ALQ124

Standard packing: Carton 100 pcs., Case 500 pcs.

LQ (ALQ)

RATING

1. Coil data

Contact arrangement	Nominal coil voltage	Pick-up voltage (at 20°C 68°F)	Drop-out voltage (at 20°C 68°F)	Nominal operating current [±10%] (at 20°C 68°F)	Coil resistance [±10%] (at 20°C 68°F)	Nominal operating power (at 20°C 68°F)	Max. applied voltage
1 Form A	5V DC	75%V or less of nominal voltage (Initial)	5%V or more of nominal voltage (Initial)	40.0mA	125 Ω	200mW	180% of nominal voltage (at 20°C 68°F) 130% of nominal voltage (at 85°C 185°F)*4
	6V DC			33.3mA	180 Ω		
	9V DC			22.2mA	405 Ω		
	12V DC			16.7mA	720 Ω		
	18V DC			11.1mA	1,620 Ω		
	24V DC			8.3mA	2,880 Ω		
1 Form C	5V DC	75%V or less of nominal voltage (Initial)	5%V or more of nominal voltage (Initial)	80.0mA	62.5Ω	400mW	150% of nominal voltage (at 20°C 68°F) 110% of nominal voltage (at 85°C 185°F)*4
	6V DC			66.7mA	90 Ω		
	9V DC			44.4mA	202.5Ω		
	12V DC			33.3mA	360 Ω		
	18V DC			22.2mA	810 Ω		
	24V DC			16.7mA	1,440 Ω		

2. Specifications

Characteristics	Item	Specifications		
Contact	Arrangement	1 Form A	1 Form C	
	Contact resistance (Initial)	Max. 100mΩ (By voltage drop 6 V DC 1 A)		
	Contact material	AgNi type		
Rating	Nominal switching capacity (resistive load)	5 A 30 V DC, 10 A 125 V AC, 5 A 250 V AC	N.O. side: 10 A 125 V AC, 5 A 250 V AC, 5 A 30 V DC N.C. side: 3 A 125 V AC, 2 A 250 V AC, 1 A 30 V DC	
	Max. switching power (resistive load)	150 W, 1,250 VA	N.O. side: 150 W, 1,250 VA N.C. side: 30 W, 500 VA	
	Max. switching voltage	250 V AC		
	Max. switching current	N.O.: 10 A (125V AC), N.C.: 3 A (125V AC)		
	Nominal operating power	200 mW	400 mW	
	Min. switching capacity (reference value)*1	100 mA, 5 V DC		
Electrical characteristics	Insulation resistance (Initial)	Min. 1,000 MΩ (at 500 V DC) Measurement at same location as "Breakdown voltage" section.		
	Breakdown voltage (Initial)	Between open contacts	1,000 Vrms for 1 min. (Detection current: 10 mA)	750 Vrms for 1 min. (Detection current: 10 mA)
		Between contact and coil	4,000 Vrms for 1 min. (Detection current: 10 mA)	
	Temperature rise (coil)*4	Max. 45°C 113°F (By resistive method, nominal coil voltage applied to the coil; contact carrying current: 10A, at 85°C 185°F)		
	Surge breakdown voltage*2 (Between contact and coil)	8,000 V (Initial)		
	Operate time (at nominal voltage) (at 20°C 68°F)	Max. 20 ms (excluding contact bounce time.) (Initial)		
Release time (at nominal voltage) (at 20°C 68°F)	Max. 20 ms (excluding contact bounce time, with diode) (Initial)			
Mechanical characteristics	Shock resistance	Functional	1 Form A: 294 m/s ² , 1 Form C: 196 m/s ² (Half-wave pulse of sine wave: 11 ms; detection time: 10 ∞s.)	
		Destructive	980 m/s ² (Half-wave pulse of sine wave: 6 ms.)	
	Vibration resistance	Functional	10 to 55 Hz at double amplitude of 1.6 mm (Detection time: 10 ∞s.)	
		Destructive	10 to 55 Hz at double amplitude of 2.0 mm	
Expected life	Mechanical	Min. 10 ⁷ (at 180 times/min.)		
Conditions	Conditions for operation, transport and storage*3	Ambient temperature: -40°C to +85°C -40°F to +185°F Humidity: 5 to 85% R.H. (Not freezing and condensing at low temperature)		
	Max. operating speed	20 times/min. (at nominal switching capacity)		
Unit weight		Approx. 7 g .25 oz		

* Specifications will vary with foreign standards certification ratings.

Notes: *1. This value can change due to the switching frequency, environmental conditions, and desired reliability level, therefore it is recommended to check this with the actual load.

*2. Wave is standard shock voltage of ±1.2· 50∞s according to JEC-212-1981

*3. The upper limit of the ambient temperature is the maximum temperature that can satisfy the coil temperature rise value. Refer to Usage, transport and storage conditions in NOTES.

*4. When using relays in a high ambient temperature, consider the pick-up voltage rise due to the high temperature (a rise of approx. 0.4% V for each 1°C 33.8°F with 20°C 68°F as a reference) and use a coil impressed voltage that is within the maximum applied voltage range.

3. Expected electrical life

Condition: Resistive load, at 20°C 68°F, at 20 times/min., with diode

Type	Switching capacity	No. of operations
1 Form A (at 20 times/min.)	10 A 125 V AC 5 A 250 V AC 5 A 30 V DC	5 · 10 ⁴ 5 · 10 ⁴ 10 ⁵
1 Form C (at 20 times/min.)	N.O.	5 · 10 ⁴ 5 · 10 ⁴ 10 ⁵
	N.C.	3 A 125 V AC 2 A 250 V AC 1 A 30 V DC

REFERENCE DATA

1.-(1) Max. switching capacity (1 Form A type)

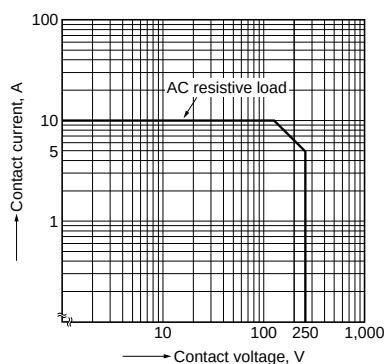

1.-(2) Max. switching capacity (1 Form C type)

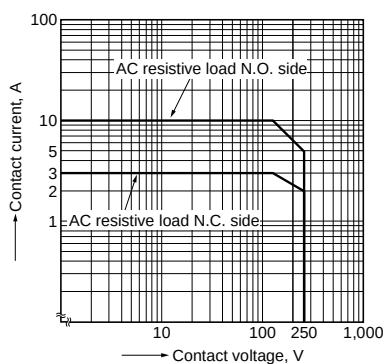

2. Life curve

Ambient temperature: room temperature

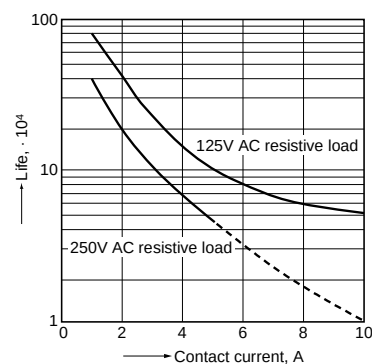

3.-(1) Coil temperature rise (1 Form A type)

Contact carrying current: 5 A, 10 A
Measured portion: Inside the coil

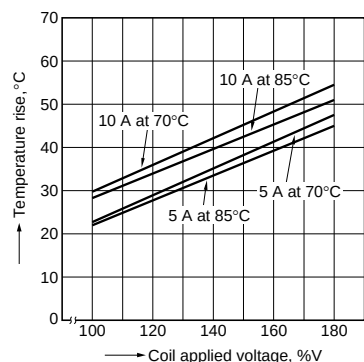

3.-(2) Coil temperature rise (1 Form C type)

Contact carrying current: 5 A, 10 A
Measured portion: Inside the coil

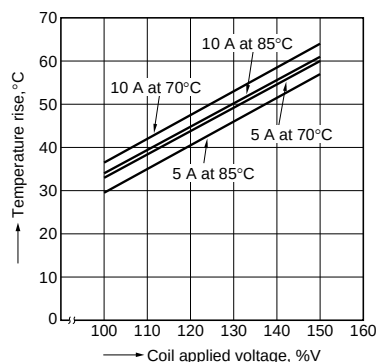

4.-(1) Ambient temperature characteristics (1 Form A type)

Contact carrying current: 5 A, 10 A

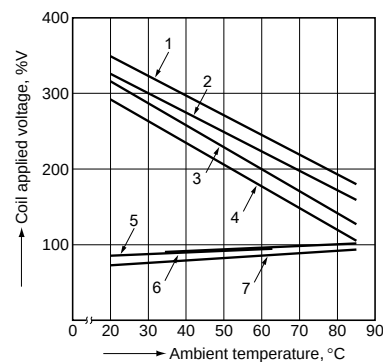

4.-(2) Ambient temperature characteristics (1 Form C type)

Contact carrying current: 5 A, 10 A

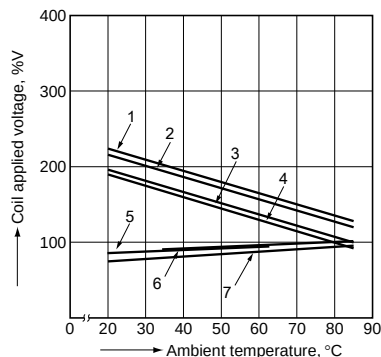

- 1 Allowable ambient temperature against % coil voltage (max. inside the coil temperature set as 130°C 266°F) (Carrying current: 5 A)
- 2 Allowable ambient temperature against % coil voltage (max. inside the coil temperature set as 130°C 266°F) (Carrying current: 10 A)
- 3 Allowable ambient temperature against % coil voltage (max. inside the coil temperature set as 115°C 239°F) (Carrying current: 5 A)
- 4 Allowable ambient temperature against % coil voltage (max. inside the coil temperature set as 115°C 239°F) (Carrying current: 10 A)
- 5 Pick-up voltage with a hot-start condition of 100%V on the coil (Carrying current: 10 A)
- 6 Pick-up voltage with a hot-start condition of 100%V on the coil (Carrying current: 5 A)
- 7 Pick-up voltage

LQ (ALQ)

DIMENSIONS (mm inch)

The CAD data of the products with a **CAD Data** mark can be downloaded from: <http://industrial.panasonic.com/ac/e/>

CAD Data



External dimensions

1 Form A

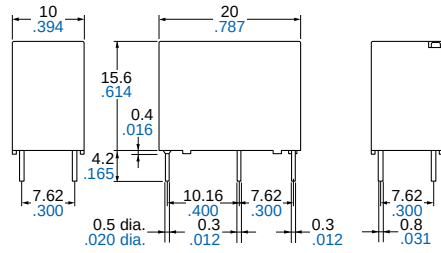

1 Form C

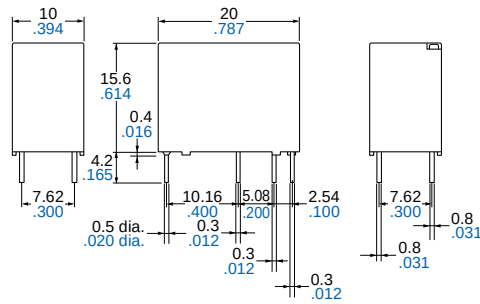

Schematic (Bottom view)

1 Form A

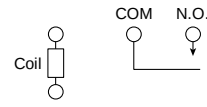

1 Form C

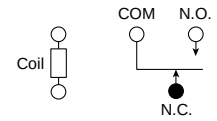

PC board pattern (Bottom view)

1 Form A

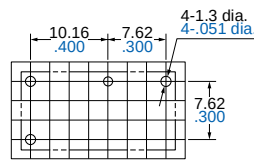

1FormC

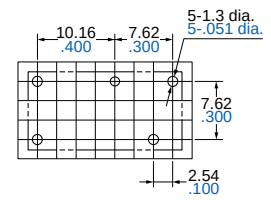

Tolerance: $\pm 0.1 \pm 0.004$

Dimension:

Less than 1mm **.039inch**:

Min. 1mm **.039inch** less than 5mm **.197 inch**: $\pm 0.3 \pm 0.12$

Min. 5mm **.197 inch**:

General tolerance

$\pm 0.2 \pm 0.08$

$\pm 0.3 \pm 0.12$

$\pm 0.4 \pm 0.16$

SAFETY STANDARDS

Item	UL/C-UL (Recognized)		VDE (Certified)	
	File No.	Contact rating	File No.	Contact rating
1 Form A	E43028	10A 125V AC 5A 277V AC 5A 30V DC 4FLA/4LRA 277V AC 1/6 HP 125V AC 1/6 HP 277V AC	40032836	5A 250V AC (cos φ=1.0) 10A 250V AC (cos φ=1.0) 10A 250V AC (cos φ=0.4) 5A 30V DC (0ms)
1 Form C	E43028	<N.O.> 10A 125V AC 5A 277V AC 5A 30V DC 4FLA/4LRA 277V AC 1/6 HP 125V AC 1/6 HP 277V AC <N.C.> 3A 125V AC 2A 277V AC 1A 30V DC	40032836	<N.O.> 5A 250V AC (cos φ=1.0) 10A 250V AC (cos φ=1.0) 10A 250V AC (cos φ=0.4) 5A 30V DC (0ms) <N.C.> 3A 250V AC (cos φ=0.4)

Note) CSA standard: Certified by C-UL

NOTES

Usage, transport and storage conditions

1) Temperature:

-40 to +85°C **-40 to +185°F**

2) Humidity: 5 to 85% RH

(Avoid freezing and condensation.)

The humidity range varies with the temperature. Use within the range indicated in the graph below.

3) Atmospheric pressure: 86 to 106 kPa

Temperature and humidity range for usage, transport, and storage

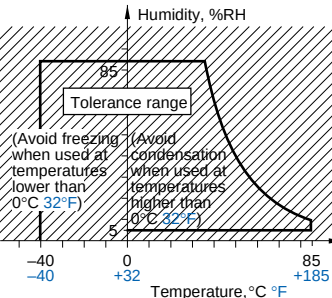

4) Condensation

Condensation forms when there is a sudden change in temperature under high temperature and high humidity conditions. Condensation will cause deterioration of the relay insulation.

5) Freezing

Condensation or other moisture may freeze on the relay when the temperatures is lower than 0°C 32°F. This causes problems such as sticking of movable parts or operational time lags.

6) Low temperature, low humidity environments

The plastic becomes brittle if the relay is exposed to a low temperature, low humidity environment for long periods of time.

Solder and cleaning conditions

1) Please obey the following conditions when soldering automatically.

(1) Preheating: Within 120°C 248°F (solder surface terminal portion) and within 120 seconds

(2) Soldering iron: 260°C±5°C 500°F±41°F (solder temperature) and within 6 seconds (soldering time)

2) Do not use ultrasonic cleaning. This will adversely affect relay characteristics. When cleaning the relay, please use alcoholic solvents.

Cautions for use

1) For precautions regarding use and explanations of technical terminology, please refer to our web site.

(panasonic-electric-works.net/ac)

2) To ensure good operation, please keep the voltage on the coil ends to ±5% (at 20°C 68°F) of the rated coil operation voltage. Also, please be aware that the pick-up voltage and drop-out voltage may change depending on the temperature and conditions of use.

3) Keep the ripple rate of the nominal coil voltage below 5%.

4) The cycle lifetime is defined under the standard test condition specified in the JIS C 5442 standard (temperature 15 to 35°C 59 to 95°F, humidity 25 to 75%). Check this with the real device as it is affected by coil driving circuit, load type, activation frequency, activation phase, ambient conditions and other factors. Also, be especially careful of loads such as those listed below.

(1) When used for AC load-operating and the operating phase is synchronous.

Rocking and fusing can easily occur due to contact shifting.

(2) Highly frequent load-operating

When highly frequent opening and closing of the relay is performed with a load that causes arcs at the contacts, nitrogen and oxygen in the air is fused by the arc energy and HNO₃ is formed. This can corrode metal materials.

Three countermeasures for these are listed here.

- Incorporate an arc-extinguishing circuit.
- Lower the operating frequency
- Lower the ambient humidity

5) This value can change due to the switching frequency, environmental conditions, and desired reliability level, therefore it is recommended to check this with the actual load.

6) Heat, smoke, and even a fire may occur if the relay is used in conditions outside of the allowable ranges for the coil ratings, contact ratings, operating cycle lifetime, and other specifications. Therefore, do not use the relay if these ratings are exceeded.

7) If the relay has been dropped, the appearance and characteristics should always be checked before use.

8) Incorrect wiring may cause unexpected events or the generation of heat or flames.

Panasonic:

ALQ105 ALQ106 ALQ109 ALQ112 ALQ118 ALQ124 ALQ305 ALQ306 ALQ309 ALQ312 ALQ318 ALQ324