

HIGH POWER



INTEK[®]

KT-980HP

**DUAL BAND AMATEUR RADIO
VHF / UHF FM POCKET SIZE
HANDHELD TRANSCEIVER**

**144-146 MHz / 128CH / 8W
430-440 MHz / 128CH / 7W
PC PROGRAMMABLE**

**NEW "HP" VERSION
FIRMWARE v3.01**

INSTRUCTION MANUAL

Declaration of Conformity

EC Certificate of Conformity
(to EC Directive 1999/5/EC)

DECLARATION OF CONFORMITY

With the present declaration, we certify that the following products :

INTEK KT-980HP

comply with all the technical regulations applicable to the above mentioned products
in accordance with the EC Directives 1999/5/EC.

Type of product : Amateur Radio Equipment VHF/UHF

Details of applied standards : EN 301 783-1 V1.2.1, EN 301 783-2 V1.2.1
EN 301 489-1 V1.9.2, EN 301 489-15 V1.2.1
EN 60950-1+A11:2009, EN 50332-1

Manufacturer : **INTEK S.R.L.**
Via G. Marconi, 16
20090 Segrate, Italy
Tel. +3902 2695 0451 / Fax. +3902 2695 2185
E-mail : info@intek-radios.com

Contact Reference : Armando Zanni
Tel. +3902 2695 0451 / Fax. +3902 2695 2185
E-mail : info@intek-radios.com

Segrate, 10/11/2013

dr. Vittorio Zanetti
(C.E.O.)

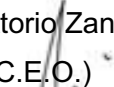

GENERAL DESCRIPTION

The transceiver is a micro-miniature multiband FM transceiver with extensive receive frequency coverage, providing local-area two-way amateur communications along with unmatched monitoring capability.

We appreciate your purchase of our transceiver, and encourage you to read this manual thoroughly, and learn about many exciting features.

SAFETY TRAINING INFORMATION



Your KT-980HP generates RF electromagnetic energy during transmitting mode. This radio is designed for and classified as "Occupational Use Only", meaning it must be used only during the course of employment by individuals aware of the hazards, and the ways to minimize such hazards. This radio is NOT intended for use by the "General Population" in an uncontrolled environment.

Electromagnetic Interference/Compatibility

During transmissions, your radio generates RF energy that can possibly cause interference with other devices or systems. To avoid such interference, turn off the radio in areas where signs are posted to do so. DO NOT operate the transmitter in areas that are sensitive to electromagnetic radiation such as hospitals, aircraft, and blasting sites.

Occupational/Controlled Use

The radio transmitter is used in situations in which persons are exposed as consequence of their employment provided those persons are fully aware of the potential for exposure and can exercise control over their exposure.

NOTICE !

It is recommended to carefully read this owner's manual before using the product. This will also help the user to prevent using the radio in violation of the regulations valid in the country where the product is used, as well as to avoid any possible interferences with other services.

NOTICE !

This transceiver has been factory programmed, in order to use the product immediately after purchase. The programming includes the activation of channels/frequencies in the VHF and UHF FM Amateur Bands, according to the technical rules in force for the use of this bands.

NOTICE !

This transceiver is programmable via PC, using the dedicated software (**free download at www.intek-radios.com**) and the PC interface cable (optional item). Any programming or modification of the original default setting must be made by a specialised technician or by an authorised service centre. Some functions of this transceiver might be programmed in violation of the technical rules in force for the use of the VHF and UHF FM bands. It is the user's responsibility to check that any modification to the programming will be done in compliance with the current regulations. Any modification to the product, alteration of the internal circuit, of the external structure of the radio or any programming in violation of the current regulations will automatically void the product certification and your right to use the product. INTEK S.R.L. declines any responsibility concerning any modification of the product, made by the user or by a third party, after delivery of the product.

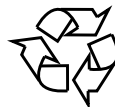
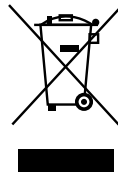

PRECAUTIONS

- Refer service to qualified technicians only.
- Do not disassemble or modify the transceiver for any reason.
- Do not expose the transceiver under direct sunlight long or to extremely hot condition.
- Do not place the transceiver on the unstable surface.
- Keep the transceiver out of dust, moisture, water.
- Do not operate the transceiver or charge the battery pack under explosive conditions.

SAFETY

It is important that the operator is aware of and understands hazards common to the operation of any transceiver.



WARNING

Please turn the transceiver off at the following locations:

- ▶ In explosive atmospheres (flammable gas, dust particles, metallic powders, grain powders, etc.).
- ▶ While taking on fuel or while parking at gasoline service stations.
- ▶ Near explosives or blasting sites.
- ▶ In medical institutes or aircrafts.

changes or modifications not expressly approved by the party responsible for compliance could void the user's authority to operate the equipment.

CONTENTS

UNPACKING AND CHECKING EQUIPMENTS / OPTIONAL ACCESSORIES	01
INSTALLATION OF ACCESSORIES	02
BATTERY INSTALLATION	03
CHARGING	03
BATTERY INFORMATION	04-05
POWER LEVELS AND RADIO OPERATION	06
PARTS, CONTROLS AND KEYS	07-09
LCD DISPLAY	10
1750 Hz TONE FOR ACCESS TO REPEATERS	11
BASIC OPERATION	11
-RADIO ON-OFF /VOLUME CONTROL	11
-SELECTING A FREQUENCY OR CHANNEL	11
ADVANCED OPERATION	11
-MENU DESCRIPTION	12
-SHORTCUT MENU OPERATION	12-14
-SQL (SETTING MENU OPERATION)	15
-STEP (SETTING SQUELCH LEVEL)	15
-TXP (HIGH /LOW POWER SELECTION)	15
-SAVE (BATTERY SAVE)	16
-VOX (VOICE OPERATED TRANSMISSION)	16
-W / N (WIDE/ NARROW BAND SELECTION)	16
-ABR (AUTO BACKLIGHT SETTING)	17
-TDR (DUAL WATCH /DUAL RECEPTION)	17
-BEEP (KEYPAD BEEPER ON/OFF)	17
-TOT (TIME-OUT TIMER)	17
-R-DCS (SETTING RECEIVE DCS) / R-CTCSS (SETTING RECEIVE CTCSS)	18
-T-DCS (SETTING TRANSMIT DCS) / T-CTCSS (SETTING TRANSMIT CTCSS)	19

-VOICE (SETTING VOICE GUIDE) -----	19
-ANI-ID (AUTOMATIC NUMBER IDENTIFICATION-ID CODE) -----	19
-DTMF ST (DTMF TONE OF TRANSMITTING CODE) -----	20
-S-CODE (SIGNAL CODE) -----	20
-SC-REV (SCAN RESUME METHOD) -----	21
-PTT-ID (PTT OR RELEASE PTT TO TRANSMIT THE SIGNAL CODE) -----	21
-PTT-LT (DELAY THE SIGNAL CODE SENDING) -----	22
-MDF-A (SETTING WORKINGMODE-A) -----	22
-MDF-B (SETTING WORKINGMODE-B) -----	22
-BCL (BUSY CHANNEL LOCKOUT) -----	23
-AUTOLK (KEYPAD LOCKED AUTOMATICALLY) -----	23
-SFT-D (DIRECTION OF FREQUENCY SHIFT) -----	23
-OFFSET (FREQUENCY SHIFT) -----	24
-MEM-CH (STORED MEMORY CHANNEL) -----	24
-DEL-CH (DELETE CHANNEL) -----	25
-WT-LED (ILLUMINATION DISPLAY COLOR OF STANDBY) -----	25
-RX-LED (ILLUMINATION DISPLAY COLOR OF RECEPTION) -----	26
-TX-LED (ILLUMINATION DISPLAY COLOR OF TRANSMITTING) -----	26
-AL-MOD (ALARM MODE) -----	26
-BAND (BAND SELECTION) -----	26
-TDR-AB (TRANSMITTING SELECTION WHILE IN DUAL WATCH RECEPTION) -----	27
-STE (TAIL TONE ELIMINATION) -----	27
-RP-STE (TAIL TONE ELIMINATION IN COMMUNICATION THROUGH REPEATER) -----	28
-RPT-RL (DELAY THE TAIL TONE REPEATER) -----	28
-PONMSG (BOOT DISPLAY) -----	28
-ROGER (TONE END OF TRANSMISSION) -----	29
-RESET (RESTORE TO DEFAULT SETTING) -----	29
CTCSS/DCS SCAN -----	29
TROUBLESHOOTING -----	30-31
SPECIFICATIONS -----	32
GENERAL INFORMATION -----	33

MAIN FUNCTIONS

- Dual Band (144-146 MHz / 430-440 MHz)
- Dual Display and Dual Watch
- High / Mid / Low RF Power Selection
- Up to 128 memory channels
- DTMF Signaling / (PTT ID Encode)
- 1800mAh Li-ion Battery
- FM Radio (87.5-108 MHz)
- CTCSS & DCS
- RX CTCSS & DCS Scan
- Voice Operated Transmission (VOX)
- Emergency Alarm / SOS
- Wide /Narrow Bandwidth selectable
- Illumination Display & Programmable Keyboard
- Beep Function
- Frequency Step 2.5 /6.25 /10/12.5/25kHz
- "OFFSET" Function
- Battery Save (SAVE)
- Time-out Timer (TOT)
- Multi Scan Mode
- Busy Channel Lockout (BCLO)
- Built-in LED Flashlight
- Programmable by PC
- Squelch Level (0-9)
- Crossband Reception
- Tone end of Transmission

UNPACKING AND CHECKING EQUIPMENTS

Unpack the transceiver and identify the items below before wasting the packing material. If any item is missing or is damaged, please contact your dealer immediately.



Transceiver

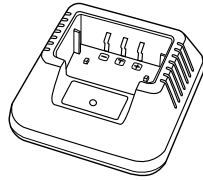

Charger

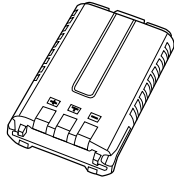

Li-Ion Battery

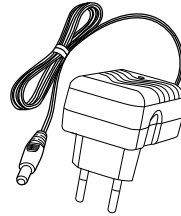

AC Adaptor

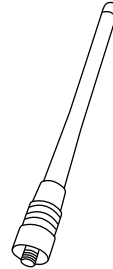

Antenna

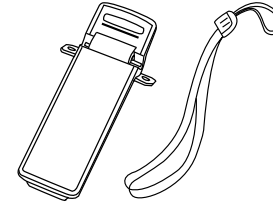

Belt Clip &
Handstrap

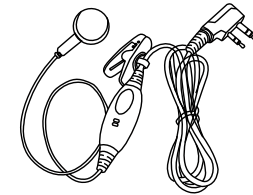

Earset-Microphone

Note: Items included in the package may differ from those listed in the table above, depending on the country of purchase. For more information consult with the dealer or retailer.

OPTIONAL ACCESSORIES

- KME-315 External Earset-Microphone with tie clip
- KME-614 External Earset-Microphone with adjustable ear hook
- KME-801 External Earset-Microphone for security and bodyguard
- KME-100A External Earset-Microphone with tie clip
- KME-200A External Earset-Microphone with flexible boom mic and tie clip
- KME-H115 External Speaker-Microphone (light duty)
- KST-301 External Speaker-Microphone (heavy duty)
- ESM-960 External Earset-Microphone Smile Design
- KPG-33 PC interface USB cable

Please check www.intek-radios.com for any new available accessory for your radio.

INSTALLATION OF ACCESSORIES

INSTALLING THE ANTENNA

Install the antenna as shown in the figure below and turn it clockwise until it stops.

Note:

- When installing the antenna, don't rotate it by its top, holding it by its base and turn.
- If you use an external antenna, make sure the 'SWR' is about 1.5:1 or less, to avoid damage to the transceiver's final transistors.
- Do not touch or hold the antenna with your hand or wrap the outside of it to avoid bad operation of the transceiver
- Never transmit without an antenna.

INSTALLING THE BELT CLIP

If necessary, install the belt clip at the rear of the battery compartment cover as shown in the figure below.

Note:

- Do not use any kind of glue to fix the screw on the belt clip. The solvents Glue may damage the battery casing.

INSTALLATION OF EXTERNAL MICRO-HEADSET

Plug the external micro-headset connector into the jack of 'SP. & MIC' of the transceiver as shown in the figure below.

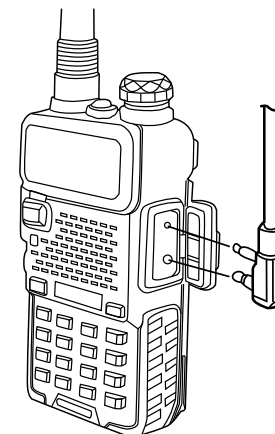
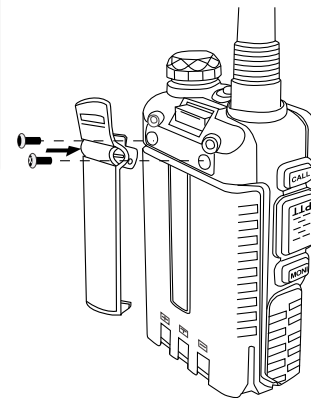
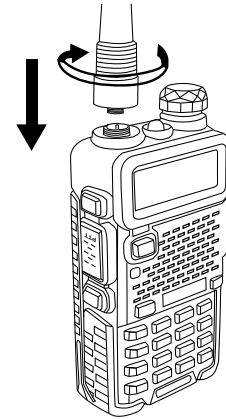

BATTERY INSTALLATION

- When attaching the battery, make sure the battery is in parallel and in good contact with the aluminum chassis. The battery bottom is about 1 to 2 centimeters below the bottom of the radio's body.
- Align the battery with the guide rails on the aluminum chassis and slide it upwards until a 'click' is heard.
- The battery latch at the bottom locks the battery.
- Turn off the radio before removing the battery.
- Slide the battery latch, at the bottom of the radio's body, in the direction indicated by the arrow.
- Slide down the battery for about 1 to 2 centimeters, and then remove the battery from the radio's body.

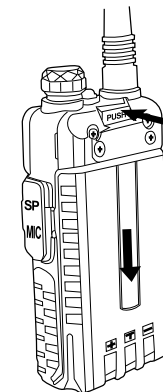
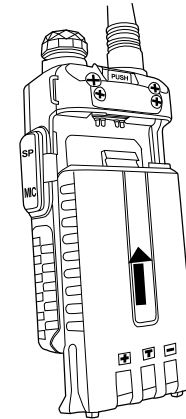

CHARGING

Use only the charger specified by the manufacturer. The charger's LED indicates the charging progress.

Charging Status	LED Indication
Standby(no-load)	Red LED flashes,while Green LED glows
Charging	Red LED solidly glows
Fully Charged	Green LED solidly glows
Error	Red LED flashes,while Green LED glows

Please follow these steps:

1. Plug the power cord into the adapter.
2. Plug the AC connector of the adapter into the AC outlet socket.
3. Plug the DC connector of the adapter into the DC socket on the back of the charger.
4. Place the radio with the battery attached, or the battery alone, in the charger.
5. Make sure the battery is in good contact with the charging terminals. The charging process initiate when the red LED lights.
6. After 4 hours ,the green LED lights which indicates the battery is fully charged. Then remove the radio with the battery attached or the battery alone from the charger.



BATTERY INFORMATION

INITIAL USE

New batteries are shipped uncharged fully from the factory. Charge a new battery for 5 hours before initial use. The maximum battery capacity and performance is achieved after three full charge/discharge cycles. If you notice the battery power runs low, please recharge the battery.



WARNING: To reduce the risk of injury, charge only the battery specified by the manufacturer. Other batteries may burst, causing bodily injury and property damage. Dispose of batteries according to local regulations (e.g. recycling). Do not dispose as household waste. Never attempt to disassemble the battery.

BATTERY TIPS

1. When charging your battery, keep it at a temperature among 5°C - 40°C. Temperature out of the limit may cause battery leakage or damage.
2. When charging a battery attached to a radio, turn the radio off to ensure a full charge.
3. Do not cut off the power supply or remove the battery when charging a battery.
4. Never charge a battery that is wet. Please dry it with a soft cloth prior to charge.
5. The battery will eventually wear out. When the operating time (talk-time and standby time) is noticeably shorter than normal performance, it is time to buy a new battery.

EXTEND BATTERY LIFE

1. Battery performance will be greatly decreased at a temperature below 0°C. A spare battery is necessary in cold weather. The cold battery unable to work in this situation may work under room temperature, so keep it for later use.
2. The dust on the battery contact may cause the battery cannot work or charge. Please use a clean dry cloth to wipe it before attaching the battery to the radio.

BATTERY STORAGE

1. Fully charge a battery before you store it for a long time, to avoid battery damage due to over-discharge.
2. Recharge a battery after several month's storage (Li-ion) batteries : (6 months), to avoid battery capacity reduction due to over-discharge.
3. Store your battery in a cool and dry place under room temperature, to reduce self-discharge.

POWER LEVELS AND RADIO OPERATION

GENERAL INFORMATION

The new Dual Band handheld radio INTEK KT-980HP is the new High Power version of the well known model KT-960 PLUS (UV-5R). The main difference and feature of model KT-980HP is the new transmitter circuit design which is equipped with a RENESAS RQA0011DNS Silicon N-Channel RF power MOSFET semiconductor, rated at 10,47W with +40.2 dBm (f=520 MHz), but derated to 8,00W max for optimum and stable operation.

RADIO OPERATION

It is always recommended that the transmitter output power level is set at the lowest level at which the communication can be carried out. The power level should be increased to a higher level only when necessary. The LOW (L) transmitter power level is about 1.0W and the MID (M) transmitter power level is about 4W, these two power levels correspond to the usual power levels for VHF/UHF handheld radios. The HIGH (H) transmitter power level is about 8.0W (VHF) / 7.0W (UHF) and it should be used only when necessary, because the current drain at this level is much higher than in the LOW and MID levels, which will obviously cause a shorter battery life. Radio should also be operated in HIGH (H) transmitter power level only when the battery is fully charged. The maximum transmitter output power in HIGH (H) transmitter power level is available only in the Amateur Radio frequency bands of 144-146 MHz and 430-440 MHz. Out of these frequency ranges the transmitter output power will be lower.

POWER LEVELS	BANDS	
	VHF	UHF
HIGH (H)	8W	7W
MID (M)	4W	4W
LOW (L)	1W	1W

PARTS, CONTROLS AND KEYS

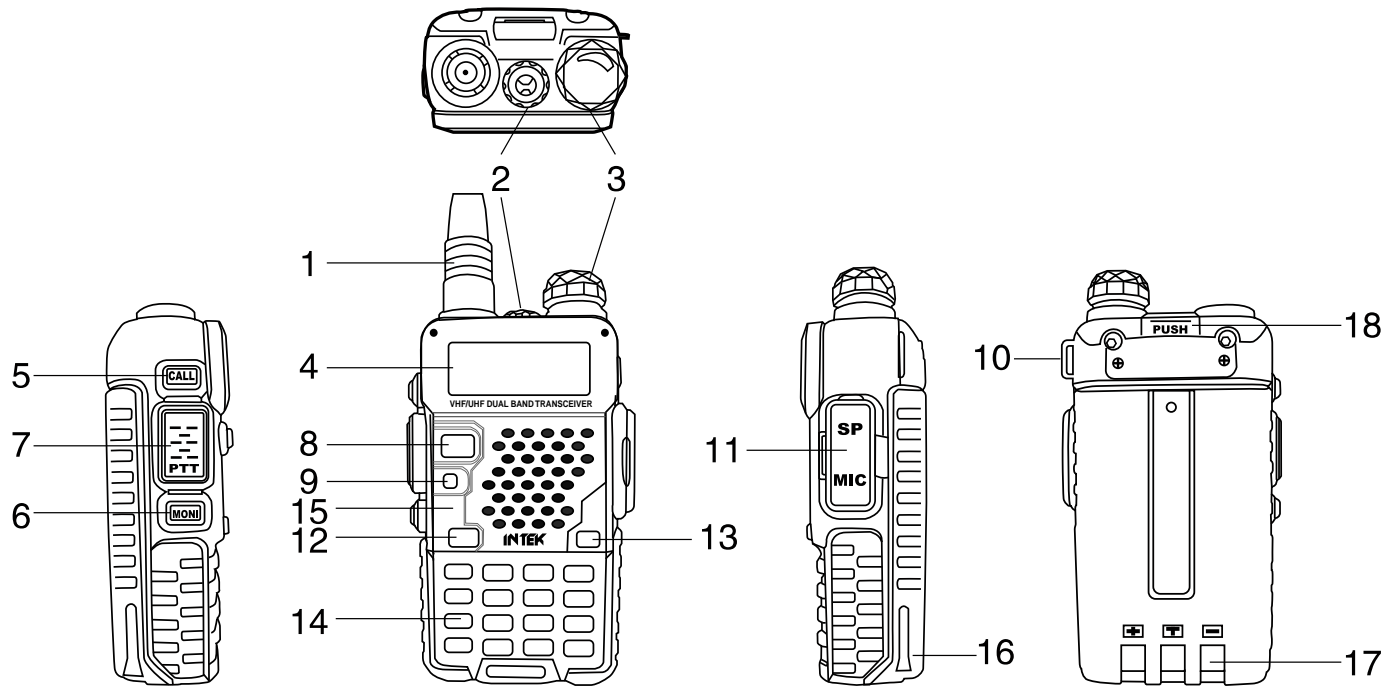

1. Antenna (Dual Band)	7. PTT Key (Push-To-Talk)	13. BAND Key (Band switch)
2. Flashlight	8. VFO/MR (Freq. Mode/CH Mode)	14. Keypad
3. Knob (ON/OFF, Volume)	9. LED Indicator	15. SP.&MIC.
4. LCD Display	10. Strap Buckle	16. Battery Pack
5. SK-1/Call (FM Radio, Alarm)	11. Accessory Jack	17. Battery Contacts
6. SK-2/MONI (Flashlight, Monitor)	12. A/B Key (Freq. display switch)	18. Battery Remove Button

COMMAND/KEY DEFINITION

▶ **[PTT] (PUSH-TO-TALK):**

Press and hold down the [PTT] button to transmit; release it to receive.

▶ **SK-SIDE KEY1/ [CALL]:**

- * Press the [CALL] button, to activate the FM Radio; Press it again to deactivate the FM Radio.
- * While FM radio being activated, press the [A/B] button to switch the band of FM radio (band 65-75 MHz and 87.5-108 MHz).
- * In FM Radio status, press [▲] or [▼] key to adjust the required frequency, user also can direct to input the numeric key to set the desired frequency.
- * Press and hold on the [CALL] button, to activate the alarm function; Press and hold it again, to deactivate the alarm function.

▶ **SK-SIDE KEY2/ [MONI]:**

- * Press the [MONI] button, to turn on the flashlight; press it again to turn on "SOS", press third time to exit.
Press and hold on the [MONI] button to monitor the signal.
- * Press the [MONI] button + PTT key + turn on the radio that will be into cloning mode. User can clone this transceiver of channel parameter to the other one.
- * When clone the parameter we need clone cable which connect the two transceivers.

▶ **[VFO/MR] BUTTON:**

Press the [VFO/MR] button, to switch the frequency mode and channel mode.

▶ **[A/B] BUTTON:**

In the frequency mode. Press the [A/B] button, to switch frequency display. Press [▲] or [▼] key to select the desired frequency or direct to input the numeric key to set the desired frequency.

▶ [BAND] BUTTON

Press this key to select the desired band (VHF or UHF).

In FM Radio mode, press this key to switch the band (65-75 MHz / 87.5-108 MHz).

▶ [★SCAN]KEY:

- * Press the [★SCAN] key to activate the Reverse function, it will exchange a separate reception and transmission frequency.
- * Press the [★SCAN] key for 2 seconds to start scanning (frequency channel).
- * While FM radio being activated, press the [★SCAN] key to search FM radio station.
- * While setting the RX CTCSS[MENU 10]/RX DCS[MENU 11], press the key [★SCAN] to scan the RX CTCSS/DCS.

▶ [# PTT] KEY:

- * Under channel mode, press [# PTT] key to switch High/Low transmit power.

Note: this setting is not available when TDR function (Dual Watch / Dual reception) is enabled.

- * Press [# PTT] key for 2 seconds to lock/unlock the keypad.

▶FUNCTION KEYPAD:

- * [MENU]key: To enter the menu of the radio and confirm the setting.
- * [▲] and [▼] key: Press and hold [▲]or [▼] key for frequency up or down fast.
-Press [▲]or [▼] key, the scanning will be opposite.
- * [EXIT]key: To cancel /clear or exit.



▶NUMERIC KEYPAD:

- * Used to enter information for programming the radio's lists and the non-standard CTCSS.
- * Under transmission mode, press the numeric key to send the signal code (the code should be set by PC software).

▶ ACCESSORY JACK:

The jack is used to connect audio accessories or other accessories such as PC cable.

LCD DISPLAY

The display icons appear when certain operations or specific features are activated.

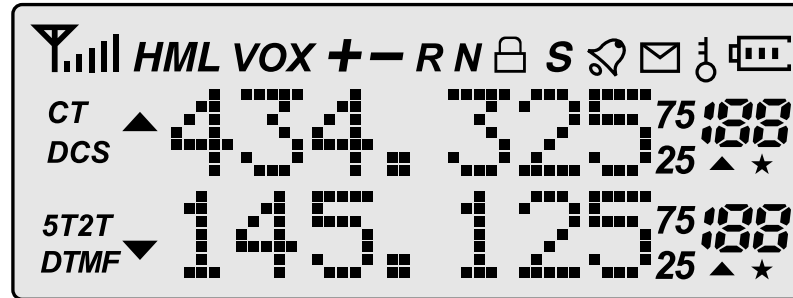

Icon	Description
188	Operating channel.
75 25	Operating frequency.
CT	'CTCSS' activated.
DCS	'DCS' activated.
+ -	Frequency offset direction for accessing repeaters.
S	Dual Watch/Dual Reception functions activated.
VOX	Function 'VOX' enabled.
R	Reverse function activated.
N	Narrow Band selected.
	Battery Level indicator
	Keypad lock function activated.
HML	RF Transmitter Power Level (High / Mid / Low).
▲ ▼	Operation frequency.
	Signal Strength Level.

1750 Hz TONE FOR ACCESS TO REPEATERS

The user needs to establish long distance communications through an amateur radio repeater which is activated after receiving a 1750 Hz tone. Press the [PTT] key + [A/B] button to transmit a 1750Hz tone.

BASIC OPERATION

1. RADIO ON-OFF/VOLUME CONTROL :

- Make sure the antenna and battery are installed correctly and the battery charged.
- Rotate the knob clockwise to turn the radio on, and rotate the knob fully counter-clockwise until a 'click' is heard to turn the radio off. Turn the knob clockwise to increase the volume, or counter-clockwise to decrease the volume.

2. SELECTING A FREQUENCY OR CHANNEL:

- Press the key [▲] or [▼] to select the desired frequency/channel.
The display shows the frequency / channel selected.
- Press and hold down the key [▲] or [▼] for frequency up or down fast.
- Use Numeric Keypad to direct input the desired frequency or channel number.

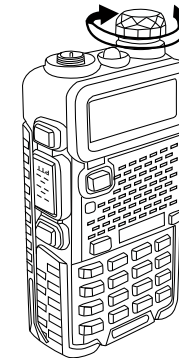

Note:

You can not select a channel if not previously stored.

ADVANCED OPERATION

You can program your transceiver operating in the setup menu to suit your needs or preferences.

1).MENU DESCRIPTION

Menu	Function/Description	Available settings
0	SQL (Squelch level)	0-9
1	STEP(Frequency step)	2.5/5/6.25/10/12.5/25kHz
2	TXP(Transmit power)	HIGH/LOW
3	SAVE(Battery save,1:1/1:2/1:3/1:4)	OFF/1/2/3/4
4	VOX(Voice operated transmission)	OFF/0-10
5	W/N(Wideband/narrowband)	WIDE/NARROW
6	ABR(Display illumination)	OFF/1/2/3/4/5s
7	TDR(Dual watch/dual reception)	OFF/ON
8	Beep(Keypad beep)	OFF/ON
9	TOT (Transmission timer)	15/30/45/60.../585/600 seconds
10	R-DCS(Reception digital coded squelch)	OFF/D023N...D754I
11	R-CTS(Reception continuous tone coded squelch)	67.0Hz...254.1Hz
12	T-DCS(Transmission digital coded squelch)	OFF/D023N..D754I
13	T-CTS(Transmission continuous tone coded squelch)	67.0Hz...254.1Hz
14	VOICE (Voice Prompt)	OFF/ON
15	ANI(Automatic number identification of the radio, only can be set by PC software)	
16	DTMFST(The DTMF Tone of Transmitting Code)	OFF/DT-ST/ANI-ST/DT+ANI
17	S-CODE(Signal code,only could be set by PC software)	ANI 1,...15 groups
18	SC-REV(Scan resume method)	TO/CO/SE

Menu	Function/Description	Available Settings
19	PTT-ID (press or release the PTT button to transmit the signal code)	OFF/BOT/EOT/BOTH
20	PTT-LT (Delay the signal code sending)	0,...30ms
21	MDF-A (Under channel mode,a channel displays. Note : name display only can be set by PC software)	FREQ/CH/NAME
22	MDF-B (under channel mode, A channel displays. Note :name display only can be set by PC software)	FREQ/CH/NAME
23	BCL (Busy Channel Lockout)	OFF/ON
24	AUTOLK (Keypad Locked Automatically)	OFF/ON
25	SFT-D (Direction of Frequency Shift)	OFF/+/-
26	OFFSET (Frequency Shift)	000,...69.9990
27	MEMCH (Stored In Memory Channels)	000,...127
28	DELCH (Delete The Memory Channels)	000,...127
29	WT-LED (illumination display color of standby)	OFF/BLUE/ORANGRE/PURPLE
30	RX-LED (illumination display color of reception)	OFF/BLUE/ORANGRE/PURPLE
31	TX-LED (illumination display color of transmitting)	OFF/BLUE/ORANGRE/PURPLE
32	AL-MOD (alarm mode)	SITE/TONE/CODE
33	BAND (band selection)	VHF / UHF
34	TDR-AB (transmitting selection while in dual watch / reception)	

Menu	Function/Description	Available settings
35	STE (Tail Tone Elimination)	OFF/ON
36	PR_STE(Tail tone elimination in communication through repeater)	OFF/1,2,3...10
37	RPT_RL(delay the tail tone of repeater)	OFF/1,2,3...10
38	PONMGS(Boot display)	FULL/MGS
39	ROGER(Tone end of transmission)	ON/OFF
40	RESET (Restore to default setting)	VFO/ALL

2).SHORTCUT MENU OPERATION

- 1.Press the key MENU,then press the key ▲ or ▼ to select the desired menu.
- 2.Press the key MENU again, come to the parameter setting.
- 3.Press the key ▲ or ▼ to select the desired parameter.
- 4.Press the key MENU to confirm and save, press the key EXIT to cancel setting or clear the input.

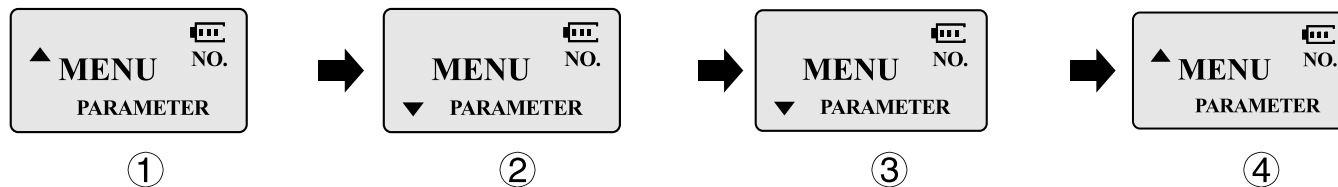

Note:

Under channel mode,the following menu settings are invalid:CTCSS,DCS,W/N,PTT-ID,BCL,SCAN ADD TO,S-CODE,CHANNEL NAME.Only the H/L power could be changed.

0."SQL" (Setting Squelch Level) (Menu+0)

- The squelch mute the speaker of the transceiver in the absence of reception. With the squelch level correctly set, you will hear sound only while actually receiving signals and significantly reduces battery current consumption.
- In standby,press [MENU] ,the screen will display "SQL".Press [MENU] enter, press [▲] or [▼] to select the desired level.Press [MENU] to confirm ,then press [EXIT] to return to standy.

Note :

This transceive has steps from 0-9,which step 0 is alway open squelch. From 1 to 9 gives different levels of noise reduction. We recommend setting squelch level to 5

1. STEP (Channel Step Selection) (Menu+1)

- In frequency mode, Press [MENU] +[1STEP]the screen will display STEP,press [MENU] enter, press [▲] or [▼] to change frequency step, Press [MENU] to confirm, then press [EXIT] to return to standby.
- This transceiver has the option of 2.5KHz, 5KHz, 6.25KHz, 10KHz, 12.5KHz, 25KHz steps.

Note:

In channel mode the settings are not available to change.

2. TXP (High / Mid / Low Power Selection) (Menu+2)

In standby mode, press [MENU] + [2TXP] keys; the LCD will show the **TXP** indication. Press [MENU] key again then press [▲] or [▼] keys to select the desired power level (HIGH, MID or LOW). Press [MENU] key to confirm then press [EXIT] key to return to standby.

Please refer to Power Levels Chart at page 6.

3. SAVE (Battery Save)(Menu+3)

In standby ,press [MENU] + [3SAVE] and then screen will display 'SAVE' .Press [MENU] enter,press [▲] or [▼] to select one of 1 ,2 ,3, 4/OFF.Press [MENU] to confirm ,then press [EXIT] to return to standby.

Note:

1, 2, 3 ,4 means the radio receive circuit turn on and off pluse ratio.

4. VOX (Voice Operated Transmission)(Menu+4)

- This function is not necessary to push the [PTT] on the transceiver for a transmission.
- Transmission is activated automatically by detecting the radio voice.
- When finish speaking, the transmission automatically terminated and the transceiver will automatically receive signal. Be sure to adjust the VOX Gain level to an appropriate sensitivity to allow smooth transmission.
- Press [MENU] + [4VOX] and then screen will display 'VOX'. Press [MENU] enter, press [▲] or [▼] to select VOX OFF or to switch on the 1 to 10 different sensitivity levels. Press [MENU] to confirm ,then press [EXIT] to return to standby .

Note:

When level is too high the VOX needs more volume to get activated. User don't press PTT that can talk to other user after activated VOX function; VOX Gain Level from 1 to 10 .

5. W/N (Wide/Narrow Band Selection)(Menu+5)

- In areas where the RF signals are saturated, you must use the narrow band of transmission to avoid interference in adjacent channels.
- In standby ,press [MENU] + [5WN] and then screen will display 'W/N' .Press [MENU] enter, press [▲] or [▼] to select Wide or Narrow. Press [MENU] to confirm ,then press [EXIT] to return to standby.

6. ABR (Auto Backlight Setting)(Menu+6)

In standby ,press [MENU] + [6ABR] and then screen will display 'ABR' .Press [MENU] enter, press [▲] or [▼] to select the auto backlight (1, 2, 3, 4, 5 second) or when you want to switch OFF backlight .Press [MENU] to confirm ,then press [EXIT] to return to standby.

Note:

Time of auto backlight of this transceiver has 5 levels of which 1 second difference.

7. TDR (Dual Watch / Dual Reception)(Menu+7)

- This feature allows you to operate between frequency A and frequency B. Periodically, the transceiver checks whether a signal is received on another frequency that we have scheduled. If you receive a signal, the unit will remain in the frequency until the received signal disappears.
- In standby ,press [MENU] + [7TDR] and then screen will display 'TDR'. Press [MENU] enter ,press [▲] or [▼] to select 'TDR' OFF or ON. Press [MENU] to confirm ,then press [EXIT] to return to standby.

8. BEEP (Keypad Beeper ON/OFF)(Menu+8)

In standby ,press [MENU] + [8BEEP] and then screen will display 'BEEP' .Press [MENU] enter, press up or down to select ON turn on beeprompt or OFF. Press[MENU] to confirm, then press[EXIT] to return to standby

9. TOT (Time-out Timer)(Menu+9)

- This function can automatically control the time we transmit each time you press [PTT] on the transceiver. This feature is very useful to avoid overheating excessive power transistors of the transceiver. The transceiver will be off transmission automatically once the set time.

- In standby ,press [MENU] + [9TOT] and then screen will display 'TOT'.Press [MENU] enter ,press [▲] or [▼] to select 'the level you need when on transmitting. Press [MENU] to confirm ,then press [EXIT] to return to standby.

This transceiver can be set in 40 steps of 15 seconds, between 15 from 600 seconds.

10. R-DCS(Setting Receive DCS)(Menu+10)

In standby ,press [MENU] + [Number key 10] and then screen will display 'R-DCS' . Press [MENU] enter, press [▲] or [▼] to select OFF or one of the DCS value between D023N to D754I . Press [MENU] to confirm ,then press [EXIT] to return to standby.

Note :

This transceiver has 105 groups different DCS codes.And D***N means positive code ,D***I means negative code. The range of positive code is between D023N to D754N,negative code is between D023 I to D754I

11. R-CTCS (Setting Receive CTCSS)(Menu+11)

In standby ,press [MENU] + [Number key 11] and then screen will display 'R-CTCSS' Press [MENU] enter, press [▲] or [▼] to select OFF or one of the CTCSS value between 67Hz to 254.1Hz .Press [MENU] to confirm ,then press [EXIT] to return to standby. This transceiver has 50 groups different CTCSS tones.

CTCSS tone :67.Hz  254.1Hz .

Note:

- In some cases we only want to establish communications in a closed user group at a particular frequency or channel, for it will use "CTCSS" or code "DCS" for reception.
- The "squelch" opens only when receiving a frequency with "CTCSS" or codes "DCS" same as the programmed in your transceiver. If codes of the received signal differs from those programmed in your transceiver, the "squelch" will not open and the received signal can be heard.

- The use of 'CTCSS' or 'DCS' in a communication ,does not guarantee complete confidentiality communication.

12. T-DCS(Setting Transmit DCS)(Menu+12)

In standby ,press [MENU] + [Number key 12] and then screen will display 'T-DCS' . Press [MENU] enter, press [▲] or [▼] to select OFF or one of the DCS value between D023N to D754I .Press [MENU] to confirm ,then press [EXIT] to return to standby.

13. T-CTCS (Setting Transmit CTCSS)(Menu+13)

In standby ,press [MENU] + [Number key 13] and then screen will display 'T-CTCSS' . Press [MENU] enter, press [▲] or [▼] to select OFF or one of the CTCSS value between 67Hz to 254.1Hz .Press [MENU] to confirm ,then press [EXIT] to return to standby.This transceiver has 50 groups different CTCSS tones.

14. VOICE (Setting Voice Guide)(Menu+14)

In standby ,press [MENU] + [Number key 14] and then screen will display 'VOICE' . Press [MENU] enter, press [▲] or [▼] to select CHINESE/ENGLISH/OFF to switch the voice guide .Press [MENU] to confirm ,then press [EXIT] to return to standby.

15. ANI- ID (Automatic Number Identification-ID Code)(Menu+15)

- ANI is also known as PTT ID because an ID is transmitted when the PTT button of the radio is pressed and/or released. This ID tells the dispatcher which field radio was keyed.
- ANI-ID code only could be set by PC software.
- In standby ,press [MENU] + [Number key 15] and then screen will display 'ANI-ID' . Press [MENU] enter, Press [MENU] to confirm ,then press [EXIT] to return to standby.

16. DTMFST (DTMF Tone of Transmitting Code)(Menu+16)

- First you should set the PTT-ID as BOT/EOT/BOTH
 - 1) "OFF"—Under transmitting mode, you can't hear the DTMF tone, while you press the key to transmit the code or code automatically transmitted.
 - 2)"DT-ST"—Under transmitting mode, you can hear the DTMF tone, while you press the key to transmit the code.
 - 3)"ANI-ST"—under transmitting mode, you can hear the DTMF tone, while the code automatically transmitted.
 - 4)"DT-ANI"—under transmitting mode, you can hear the DTMF tone, while you press the key to transmit the code or the code automatically transmitted.
- In standby ,press [MENU] + [Number key 16] and then screen will display 'DTMF ST'
Press [MENU] enter, press [▲] or [▼] to select OFF or ON to switch the voice guide
Press [MENU] to confirm ,then press [EXIT] to return to standby.
- The transceiver has 4 different options :
 - 1) OFF :Turn off all
 - 2) DT+ ANI : Sidekey and ANI are both ON.
 - 3) ANI-ST : Switch on the AN sidetone when transmitting
 - 4) DT-ST : Switch on sidekey when transmitting.

17. S-CODE (Signal Code)(Menu+17)

- In standby ,press [MENU] + [Number key 17] and then screen will display 'S-CODE'
Press [MENU] enter, press [▲] or [▼] to select the desired code .
Press [MENU] to confirm ,then press [EXIT] to return to standby.

- Note:
S-CODE only could be set by PC software.

18. SC-REV (Scan Resume Method)(Menu+18)

- This transceiver allows you to scan memory channels, all the bands or part of the bands. When the transceiver detects a communication, the scan will stop automatically.
 - 1) "TO" (Time Operation):
Scanning will stop when it detects an active signal. The scanning will stop on each channel or active frequency for a predetermined time, after that time the scan will resume automatically.
 - 2) "CO" (Carrier Operation):
The scanning will stop and remain in the frequency or channel, until the active signal disappears.
 - 3) "SE"(Search Operation):
The scanning will stop and remain in the frequency or channel after it detects an active signal.
- In standby ,press [MENU] + [Number key 18] and then screen will display 'SC-REV'
Press [MENU] enter, press [▲] or [▼] to select TO,CO or SE that you desired code.
Press [MENU] to confirm ,then press [EXIT] to return to standby. .

19. PTT-ID (PTT or Release PTT to Transmit The Signal Code)(Menu+19)

- This feature allows you to know who calls you.
 - 1)"OFF" : Don't transmit the code while pushing the PTT button.
 - 2)"BOT" : Transmit the code while pushing the PTT button.(The code only could be set by PC software.)
 - 3)"EOT"-Transmit the code while releasing the PTT button.
 - 4)"BOTH"-Transmit the code while pushing or releasing the PTT button.
 - In standby ,press [MENU] + [Number key 19] and then screen will display 'PTT-ID'
Press [MENU] enter, press [▲] or [▼] to select the desired code .
Press [MENU] to confirm ,then press [EXIT] to return to standby.
- Note: PTT-ID only could be set by PC software.

20. PTT-LT (Delay The Signal Code Sending)(Menu+20)

Setting ANI ID CODE on transmit is needed to send ANI ID code everytime when you press your PTT key.

1-50: Permit transmit ANI delayed time from 1 to 50. Unit: 100ms

0: Do not delay to transmit ANI ID CODE

In standby ,press [MENU] + [Number key 20] and then screen will display 'PTT-LT'

Press [MENU] enter, press [▲] or [▼] to select you desired delay time from 1 to 50.

Press [MENU] to confirm ,then press [EXIT] to return to standby.

21. MDF-A (Setting Workingmode -A)(Menu+21)

- Under channel mode ,press [MENU] + [Number key 21] and then screen will display 'MDF-A' .Press [MENU] enter, press [▲] or [▼] to select you desired mode
FREQ/CH/NAME .Press [MENU] to confirm ,then press [EXIT] to return to standby.

- This transceiver has 3 different options.

- 1) FREQ: Under channel mode,A channel display. Channel display by frequency mode.
- 2) CH : Under channel mode,A channel display, Channel display by channel mode.
- 3) NAME: Under channel mode,A channel display, Channel display by channel name
(The name displays only can be set by PC software).

22. MDF-B (Setting Workingmode -B)(Menu+22)

- Under channel mode ,press [MENU] + [Number key 22] and then screen will display 'MDF-B' .Press [MENU] enter, press [▲] or [▼] to select you desired mode
FREQ/CH/NAME .Press [MENU] to confirm ,then press [EXIT] to return to standby.

- This transceiver has 3 different options.

- 1) FREQ: Under channel mode,B channel display, Channel display by frequency mode.
- 2) CH : Under channel mode,B channel display, Channel display by channel mode.

3) NAME: Under channel mode, B channel display, Channel display by channel name
(The name displays only can be set by PC software).

23. BCL (Busy Channel Lockout)(Menu+23)

- The BCLO feature prevents the radio's transmitter from being activated if a signal strong enough to break through the "noise" squelch is present. On a frequency where stations using different CTCSS or DCS codes may be active, BCLO prevents you from disrupting their communications accidentally (because your radio may be muted by its own tone decoder).
- In standby, press [MENU] + [Number key 23] and then screen will display 'BCL'. Press [MENU] enter, press [▲] or [▼] to select between ON or OFF. Press [MENU] to confirm, then press [EXIT] to return to standby.
- OFF: Channel busied, the transceiver still can be transmit.
ON : Channel busied, the transceiver can not be transmit.

24. AUTOLK (Keypad Locked Automatically)(Menu+24)

- The transceiver has two options : auto lock and manual lock.
OFF : Turn off auto lock .
ON : When you set autolock the keyboard will be locked within 15 seconds if you don't do any operation. To release keyboard press  for more than 2 seconds.
- In standby, press [MENU] + [Number key 24] and then screen will display 'AUTOLK'. Press [MENU] enter, press [▲] or [▼] to select keyboard lock ON or OFF . Press [MENU] to confirm, then press [EXIT] to return to standby.

25. SFT-D (Direction of Frequency Shift)(Menu+25)

- In standby, press [MENU] + [Number key 25] and then screen will display 'SFT-D'. Press [MENU] enter, press [▲] or [▼] to select your desired mode + / - / OFF . Press [MENU] to confirm, then press [EXIT] to return to standby.

- Frequency shift means :
 - OFF: Turn off frequency shift .
 - + : The transmit frequency is higher than receive frequency .
This is called positive offset (+) .
 - : The transmit frequency is lower than receive frequency .
This is called negative offset (-) .

26. OFFSET (Frequency Shift)(Menu+26)

- When communicating via a repeater, the direction of displacement of frequency should be timed to the displacement of the transmission frequency is higher or lower than the receiving frequency.
Example:
If we want to make a communication through amateur radio repeater whose frequency input is 145,000 MHz and 145,600 MHz is output, we select the "OFFSET" of the previous section in 0600 and the direction of travel "SHIFT" programmed to [-], so the transceiver will always 145,600 MHz in frequency and when you press [PTT] to transmit transceiver, the frequency will automatically move to 145,000 MHz.
- In standby ,press [MENU] + [Number key 26] and then screen will display 'OFFSET'
Press [MENU] enter, press [▲] or [▼] or press 0 to 9 to select offset frequency.
Press [MENU] to confirm ,then press [EXIT] to return to standby.
- Offset frequency refers to the difference between the transmit and receive frequency.

27. MEM-CH (Stored In Memory Channel)(Menu+27)

- When transceiver works in frequency mode or in standby, input the frequency and any kind of parameter you want to store.
- In standby ,press [MENU] + [Number key 27] and then screen will display 'MEM-CH'
Press [MENU] enter, press [▲] or [▼] to select the desired channel order .Press [MENU]

to confirm then press [EXIT] to return to standby.

- Example : you want 450.065MHz for receive and 460.065MHz for transmit and stored in CH-28, the act is as follows :

When the transceiver works in frequency mode ,input 4 5 0 0 6 5,

press [MENU]+ [Number key 27], then press [▲] or [▼] select CH-28

(the transceiver has 128 memory channel from 000 to 127.

press [MENU] to confirm,voice prompt will tell you it is stored .Press [EXIT] to exit.

- Note:

If you want to set CTCSS ,DCS ,W&N etc functions on parameter please set before stored .That can store with frequency in channel. The transmitting only can be stored transmit frequency ,if you want to store .MENU function and parameter ,please store with the receiving .If you want to store by manual in frequency mode,the channel should be vacant ,then you can go on operation of sotre receiving or transmitting or you can only go on the operation of storing transmitting. If it is not vacant you should delete channel to go on the above operation.

28. DEL-CH (Delete Channel)(Menu+28)

In standby ,press [MENU] + [Number key 28] and then screen will display 'DEL-CH'

Press [MENU] enter, press [▲] or [▼] to select the channel you want to delete.

Press [MENU] to confirm ,then press [EXIT] to return to standby.

- The transceiver has 128 memory channel from 000 to 127.Operate invalid when you into channel without CH- display,it means this channel not parameter.

29. WT-LED (Illumination Display Color of Standby)(Menu+29)

- The transceiver has four colors available:

BLUE / ORANGE /PURPLE /OFF

- In standby ,press [MENU] + [Number key 29] and then screen will display 'WT-LED'
Press [MENU] enter,press [▲] or [▼] to select the desired color BLUE /ORANGE /
PURPLE /OFF.Press [MENU] to confirm ,then press [EXIT] to return to standby.

30. RX-LED (Illumination Display color of reception)(Menu+30)

- The transceiver has four colors available : BLUE /ORANGE /PURPLE /OFF.
- In standby,press [MENU]+[Number key 30], and then screen will display 'RX-LED'
Press [MENU] enter, press [▲] or [▼] to select the desired color BLUE /ORANGE
PURPLE /OFF.Press [MENU] to confirm ,then press [EXIT] to return to standby.

31. TX-LED (Illumination Display color of transmitting)(Menu+31)

- The transceiver has four colors available :BLUE /ORANGE /PURPLE /OFF.
- In standby,press [MENU]+[Number key 31], and then screen will display 'TX-LED'
Press [MENU] enter, press [▲] or [▼] to select the desired color BLUR /ORANGE
PURPLE /OFF.Press [MENU] to confirm ,then press [EXIT] to return to standby.

32. AL-MOD (Alarm Mode)(Menu+32)

- The transceiver has three modes available :
SITE : Alarm
TONE: Sending Alarm
CODE: Sending Alarm Code
- In standby,press [MENU]+[Number key 32], and then screen will display 'AL-MOD'
Press [MENU] enter, press [▲] or [▼] to select the desired mode
SITE/ TONE/ CODE.Press [MENU] to confirm ,then press [EXIT] to return to standby

33. BAND (Band Selection)(Menu+33)

- Radio has 2 bands: VHF 144-146 (136-174) MHz / UHF 430-440 (400-470) MHz (*)

- In standby,press [MENU]+[Number key 33], and then screen will display 'BAND'
Press [MENU] enter, press [▲] or [▼] to select the desired work band of VHF / UHF.
Press [MENU] to confirm ,then press [EXIT] to return to standby.

34.TDR-AB (Transmitting Selection While In Dual Watch)(Menu+34)

- The transceiver has three options :
 - OFF : turn off dual watch
 - A : A band transmitting
 - B : B band transmitting
- In standby,press [MENU]+[Number key 34], and then screen will display 'TDR-AB'
Press [MENU] enter, press [▲] or [▼] to select the desired mode of OFF/ A / B.
Press [MENU] to confirm ,then press [EXIT] to return to standby.

35. STE (Tail Tone Elimination)(Menu+35)

- This function is used to activate or deactivate the transmission end of the transceiver
this final tone transmission only be used in communications between transceivers
and not in communications through a repeater, which must be deactivated.
- In standby,press [MENU]+[Number key 35], and then screen will display 'STE' .
Press [MENU] enter, press [▲] or [▼] to select the STE OFF or ON.
Press [MENU] to confirm ,then press [EXIT] to return to standby.
- OFF : The transceiver stop transmitting tone after releasing PTT, it wil out a sound when
it through a repeater.
- ON : The transceiver transmit tone after releasing PTT, it will suppress to hear
the sound.

36. RP-STE (Tail Tone Elimination In Communication Through Repeater) (Menu+36)

- When the transceiver transfer in a repeater ,it will into a reception status after the transmitter release PTT. The transceiver can be received a sound from repeater. User can adjust it by menu that will stop to hear a sound when it through repeater. Please set the menu as OFF If you heard this sound which confirm the repeater is working.
- In standby,press [MENU]+[Number key 36], and then screen will display 'RP-STE' Press [MENU] enter, press [▲] or [▼] to select the desired work value from 0 to 10 Press [MENU] to confirm ,then press [EXIT] to return to standby.

37. RPT-RL (Delay The Tail Tone Of Repeater)(Menu+37)

- When a transceiver transfer in a repeater, the transceiver will be confirm the repeater if transfer a signal must using delay the tail tone of repeater. Please set the menu as OFF if you don't need this sound ,it can be adjusted by menu.
- In standby, press [MENU]+[Number key 37], and then screen will display 'RPT-RL' . Press [MENU] enter, press [▲] or [▼] to select the desired work value from 0 to 10 Press [MENU] to confirm ,then press [EXIT] to return to standby.

Note: If you want to active the RPT-RL Function,you must set the STE and RP-STE function unavailable

38. PONMSG (Boot Display)(Menu+38)

- The transceiver has two options:
 - FULL : full display
 - MSG : display the radio mode

- In standby,press [MENU]+[Number key 38], and then screen will display 'PONMSG'
Press [MENU] enter, press [▲] or [▼] to select the desired mode FULL or MGS.
Press [MENU] to confirm ,then press [EXIT] to return to standby.

39. ROGER (Tone End Of Transmission)(Menu+39)

- The transceiver has two options:
ON : turn on the tone end of tansmission
OFF: turn off the tone end of tansmission
- In standby,press [MENU]+[Number key 39], and then screen willdisplay 'ROGER'
Press [MENU] enter, press [▲] or [▼] to select the desired mode OFF or ON .
Press [MENU] to confirm ,then press [EXIT] to return to standby.

40. RESET (Restore To Default Setting)(Menu+40)

- The transceiver has a menu which resets VFO and ALL message.When you use RESET VFO,all parameter will be return to factory default . When you use RESET ALL, all transceivers and channel parameter will be return to factory default.
- In standby,press [MENU]+[Number key 40], and then screen will display 'RESET' .
Press [MENU] enter, press [▲] or [▼] to select the desired work mode VFO or ALL. Press [MENU] to confirm ,then press [EXIT] to return to standby.

CTCSS/DCS Scan

Please set the correct frequency before CTCSS /DCS scanning ,and gurantee the radio can receive signal in this frequency .Set the TDR function unavailable and let it works on frequency mode .

The CTCSS /DCS SCAN step as following :

Menu +11 + */SCAN (R-CTCSS Scan)

Menu +10 + */SCAN (R-DCS Scan)

Note : In scanning status ,if you press the MENU key it will stored the current tone and return to the Menu Setting .

CT/DCS symbols will flashing on the screen when the radio is in the scanning status , If it has not any signal the number of CTCSS/DCS will stop ; it has a signal the number of the CTCSS/DCS will move fast , the radio will prompt a "DiDo" sound and stop scan when received CTCSS/DCS Tone which is the same as the Radio Tone , Press MENU to save or press EXIT to exit .

TROUBLESHOOTING

Problem	Possible cause / solution
The radio does not start.	The battery is low, replace the battery with a charged battery or proceed to the battery. The battery is not installed correctly, remove the battery and reattachit.
The battery runs down quickly.	The battery life has come to the end, replace the battery with a new one. The battery is fully charged, make sure the battery is made in full.
The receiving indicator LED lights but do not hear the speaker.	Make sure whether the volume setting is too low or not. Make sure the undertones "CTCSS" or code "DCS" are the same as those programmed in the transceiver of the other members of your group.
When transmitting, the other members of his group do not receive the communication.	Make sure the undertones "CTCSS" or code "DCS" programmed in your transceiver are the same as those programmed in the transceiver of the other members of your group. Your partner or you, are too far. You or your partner are in a bad area of RF signal propagation.
In "standby" mode, the transceiver transmits without pressing the "PTT".	Check the level adjustment function "VOX" is not set too sensitive.

Problem	Possible cause / solution
Receive communications from other user groups while communicating with your group.	Change frequency or channel. Change the undertones "CTCSS" or code "DCS" in your group.
Communication with other members of your group is poor or low quality.	You or your partner is too far away or in an area of poor radi signal propagation, such as inside a tunnel, inside an underground car park, in a mountainous area, including large metal structures, etc..
After these check, if you still have problems with the transceiver, check with your distributor, dealer or service center.	

SPECIFICATIONS

General

Frequency	VHF 144-146 MHz (136-174 MHz) (*) UHF 430-440 MHz (400-470 MHz) (*)
Channels	128
Channel steps	2.5, 5, 6.25, 10, 12.5, 25 KHz
DC input voltage	7.4 VDC
Standard Battery	1800mAh
Operating temperature	-20/+60°
Dimensions / Weight	mm 58 x 110 x 32 (main body) / 205 gr.
Current Drain (Stand-By)	≤75mA

Receiver

Sensitivity (12dB Sinad)	0.2 μV
Audio output	≤1.4V

Transmitter

RF output power	8W VHF / 7W UHF (Maximum Transmitter Output Power in the Amateur Radio Bands)
Modulation	16K*F3E/8K*F3E (W/N)
Spurious & Harmonics	in compliance with the R&TTE regulations
Current Drain	≤1.4A

FM Radio

Frequency range	87.5 - 108 MHz WFM
-----------------	--------------------

(*) KT-980HPX (INTERNATIONAL VERSION) 136-174 MHz / 400-470 MHz (not available for Europe)

General Information

Important notice !

The use of VHF and UHF FM transceivers is subject to the regulations applied in the country where the product has to be used. As regulations are usually subject to possible modifications, please check the current regulations in your country with your dealer or local supplier. INTEK does not take any responsibility for illegal use and operation of this product not in accordance with the regulation of the country where the product is used.

User Information

in accordance with art. 13 of the Legislative Decree of 25th July 2005, no. 15 "Implementation of Directives 2002/95/EC, 2002/96/EC and 2003/108/EC, relative to reduction of the use of hazardous substances in electrical and electronic equipment, in addition to waste disposal".

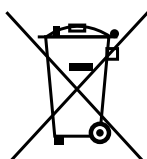

The crossed bin symbol shown on the equipment indicates that at the end of its working life the product must be collected separately from other waste.

The user must therefore take the above equipment to the appropriate differentiated collection centres for electronic and electro technical waste, or return it to the dealer when purchasing a new appliance of equivalent type, in a ratio of one to one.

Appropriate differentiated waste collection for subsequent recycling, treatment and environment-friendly disposal of the discarded equipment helps to prevent possible negative environmental and health effects and encourages recycling of the component materials of the equipment.

Illegal disposal of the product by the user will be punished by application of the administrative fines provided for by the legislative decree no. 22/1997 (article 50 and following of the legislative decree no. 22/1997).

INTEK®